

Table Of Contents

I.	Precautions Before Using The Scale-----	1
II.	Explanation Of Display Symbols-----	2
III.	Keypad Functions-----	4
IV.	Operations-----	5
	(I) Switch on & off-----	5
	(II) Zero the scale -----	5
	(III) Sampling before counting-----	5
	(IV) Preset unit weight in numeric keys -----	8
	(V) Subtract container's weight-----	9
	(VI) Weight/Quantity accumulation-----	14
	(VII) Preset counting check range-----	16
	(VIII) Preset weight check range-----	18
IV.	User Programming Functions-----	20
	(I) Auto. shut off time span-----	20
	(II) Zero Tracking Range-----	21
	(III) Zero display range-----	22
	(IV) Stable class range-----	23
	(V) Stable class rate -----	24
	(VI) Backlight type-----	25
	(VII) Change unit of measure from kg/g to Pound-----	26
	(VIII) Unit weight recomputing-----	27
	(IX) Check alarm type-----	28
	(X) Baud Rate setting-----	31
	(XI) Transmit method setting-----	32
	(XII) Label format setting (available when a label printer is connected.)-----	33
	(XIII) Cancel Tare setting-----	34
VI.	Calibration (can only be done in kg)-----	35
VII.	Power supply & battery operation-----	36
VIII.	RS-232 Output-----	37
IX.	Error Codes-----	40
X.	Technical Data-----	41

I . Precautions Before Using The Scale

Environment

The scale should always be used in an environment, which is free from excessive air currents, corrosives, vibration, and temperature or humidity extremes. These factors will affect displayed weight reading.

DO NOT install the scale:

- Next to open windows or doors causing drafts or rapid temperature changes.
- Near air conditioning or heating vents.
- Near vibrating, rotating or reciprocating equipment.
- Near magnetic fields or equipment that generates magnetic fields.
- On an unstable work surface
- In a dusty environment
- In direct sunlight.

Leveling the Scale

The scale is equipped with a level indicator on the left bottom side of the front panel and four adjustable leveling feet. Adjust the leveling feet until the bubble appears in the center circle of the indicator.

Turn on Scale

Do not turn on scale with anything on the platform.

When the scale is used with a power adapter, the switch located on the right side of scale should be on. Then press the button "ON/OFF" to turn on the scale.

When the scale is used with the battery only, press the key "ON/OFF" directly to turn on the scale.

The scale will start to count down from nine to zero. The scale is then ready for use. Give a warm-up for 15~30 minutes before use.

II. Explanation Of Display Symbols

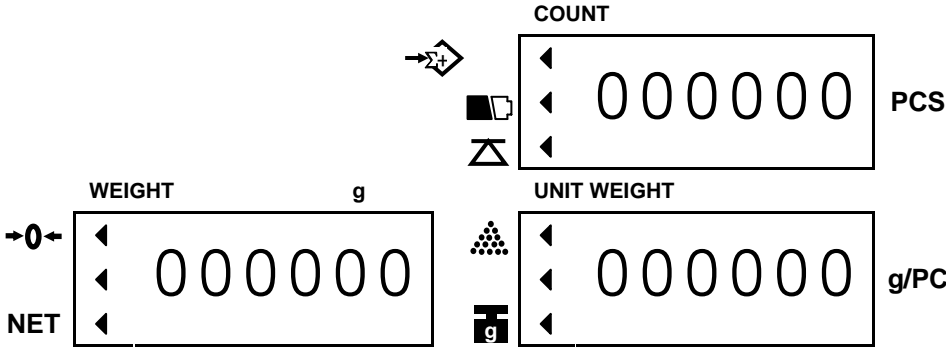

Display Windows

- **Weight Display –**

Totals 6 digits for weight accumulated or being measured on the pan.







- **Unit Weight Display –**

Totals 6 digits for unit weight or times of weight accumulated.

- **Count Display –**

Totals 6 digits for number accumulated or being counted on the pan.

Indicated Symbols

Symbols	Specification
NET	Scale is in TARE mode.
	Scale is in ZERO mode.
	Scale is in ACCUMULATION mode.
	The display reading is in STABLE condition.
	Lack of Sample Weight If the total sample weight on the pan is less than <u>10 display divisions</u> , a triangular indicator will appear to remind the user to add more samples until the indicator disappears.
	Lack of Unit Weight If the unit weight is less than <u>1/10 display divisions</u> , a triangular indicator will appear to remind the user that the displayed unit weight is too small for getting accurate quantity calculations.
	Low Voltage

III. Keypad Functions

Keys	Specification
0~9	Numeric keys
•	Decimal point key
C	Use this key to clear out the displayed numeric readings.
ZERO	If there is a minor weight displayed without anything on the pan, hit the zero key to clear the display.
TARE	Use this key to subtract the container's weight, indicates that the current weight reading is net weight.
SMPL	Use this key to input sample size.
U.WT	Use this key to input the known unit weight of item to be counted.
ALARM	Use this key to input the HIGH & LOW weight/quantity limit for check function.
ADD	Use this key to accumulate weight/quantity measured.
TOTAL	Use this key to recall total weight, count & accumulation times.
P.TARE	Use this key to preset TARE weight.
SET	Use this key to enter into User Programming Functions.
ENTER	Use this key to confirm the parameter setting.
MOVE	Use this key to move the parameter value in Set Mode.
MEMORY	Use this key to memory a value to a location.
ON/OFF	On/Off switch.

IV. Operations

(I) Switch on & off

Click the **on & off** button to turn on or turn off the scale.

(II) Zero the scale

Press **ZERO** key to return the display to zero in case there is any zero drifting while unloaded.

(III) Sampling before counting

Unknown unit weight

- Place a few pieces of item to be counted on the pan.

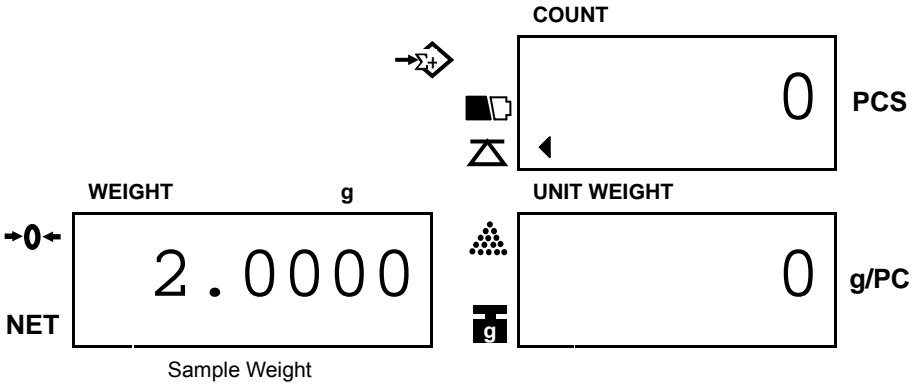

- Input the quantity of item on the pan.

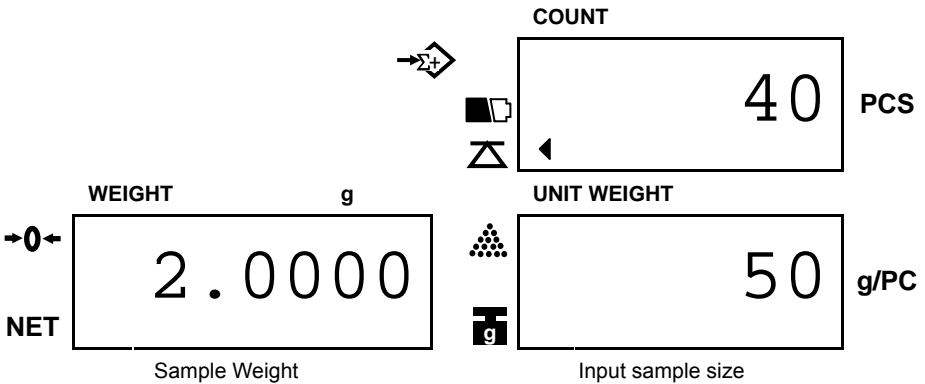

3. Press **SMPL** key

Note: The system default is “Unit Weight”. If the “SMPL” key is clicked when the value (ex.:40) in COUNT window is blinking, then the numerical value input will be as “Quantity”. If the “SMPL” key is not clicked when the value (ex.:40) in COUNT window is blinking, then the numerical value input will be as “Unit Weight”.

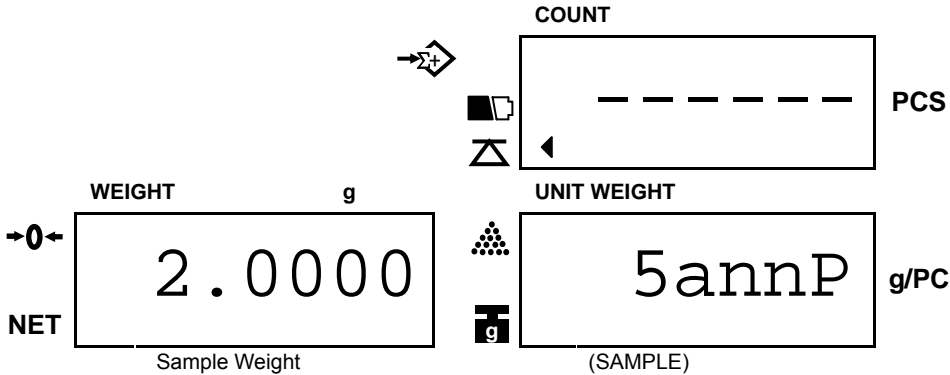

4. The sampling operation is completed while stable display appears as below :

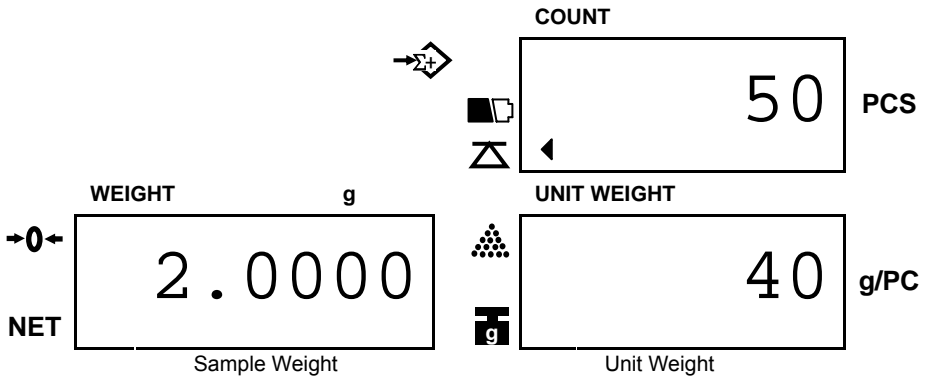

The larger sample size, the more accurate unit weight
 Press **SMPL** key to recomputing unit weight during in counting process if the setting of “Unit Weight Recomputing” set to “on” (Please refer to the section (VIII) of **V.**).

Known unit weight

1. Input the known unit weight.

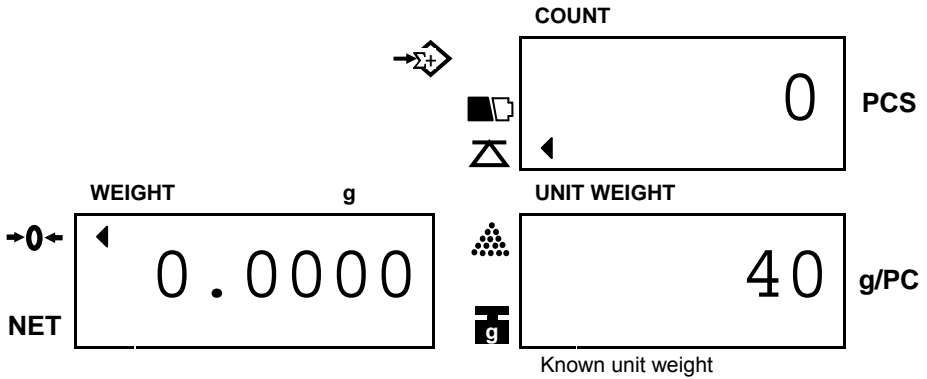

2. Press **U.Wt** key to complete sampling operation & enter into counting mode.

Note: The system default is "Unit Weight". If the "U.WT" key is clicked when the value (ex.:0) in COUNT window is blinking, then the numerical value input will be as "Unit Weight".

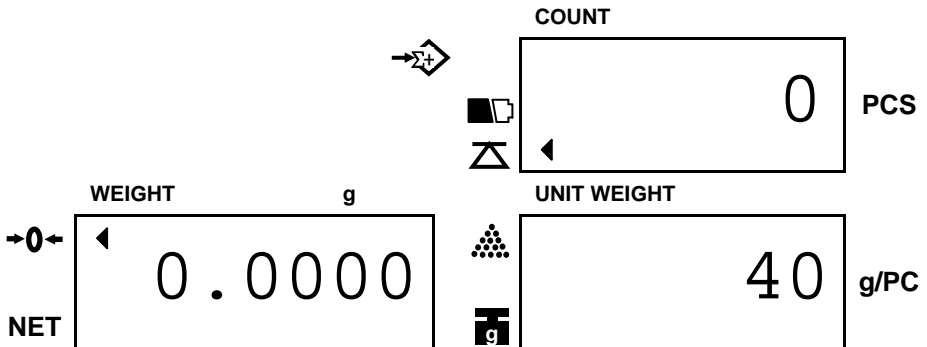

(IV) Preset unit weight in numeric keys

How to store unit weight in memory cells

1. Give a long press of **MEMORY** to enter into Memory mode, and obtain unit weight by inputting the known value (ex.35g) or by sampling operation mentioned before. Press the **ENTER** key to confirm the value.

Note: Press the “**MOVE**” key change the value when a wrong value entered.

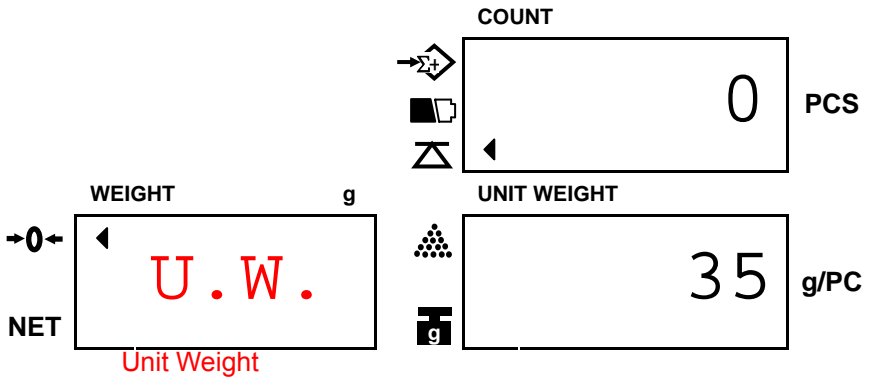

2. Enter the tare value (ex. 10g) and press the **ENTER** key to confirm the value.

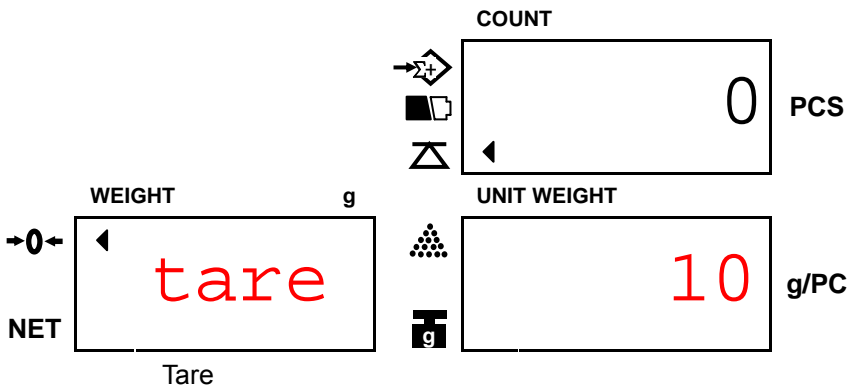

3. Enter the item number and press the **ENTER** key to confirm the value.

Note: You can enter up to 6 digits. (For example: Item number-800125)

Diagram illustrating the scale display during item number entry:

- COUNT:** 0 PCS
- WEIGHT g:** Item. no
- UNIT WEIGHT g/PC:** 8001 25

Item Number

4. Enter a address cell (1~100, total 100 cells available) by pressing any of the numeric keys (0~9), then press the **ENTER** key to store the unit weight, tare value and item number into the address cell.

Diagram illustrating the scale display during address entry:

- COUNT:** 800125 PCS
- WEIGHT g:** Addr
- UNIT WEIGHT g/PC:** s--100

Address Number

Note: 1) An error message “E4” will appear if the address code is out of “1~100”.

2) When the address number has been used, the display will remind you if you want to update the memory.

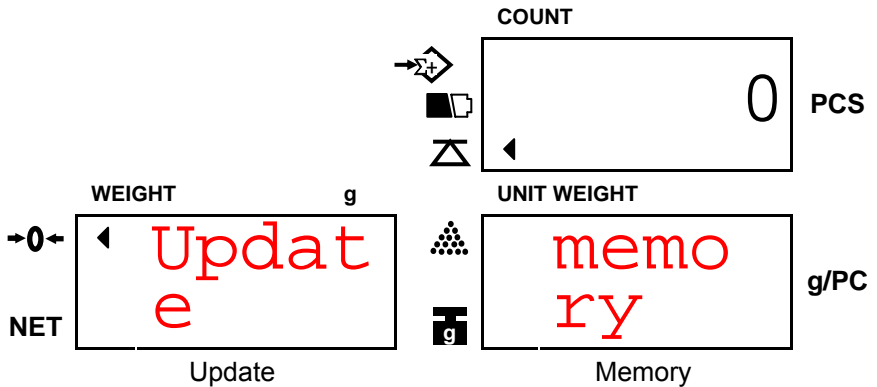

Press the **ENTER** key to confirm, then the memory will be updated.

Press the **MOVE** key to enter the new address.

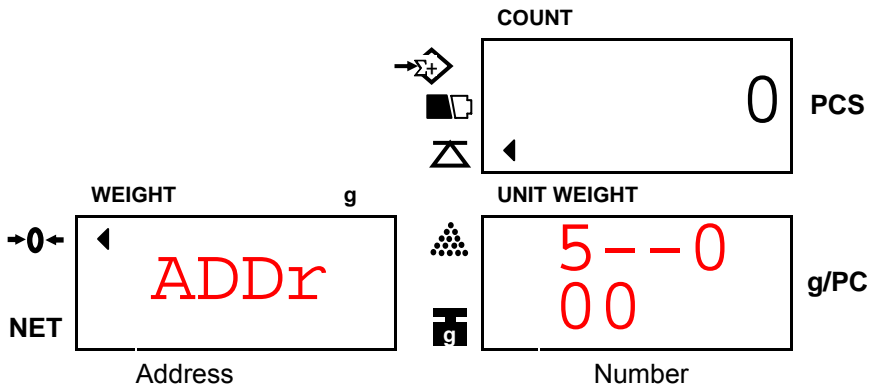

How to recall the data stored

Press the numeric key with stored data & keep pressing **MEMERY** key twice. You will see the unit weight and tare on the display.

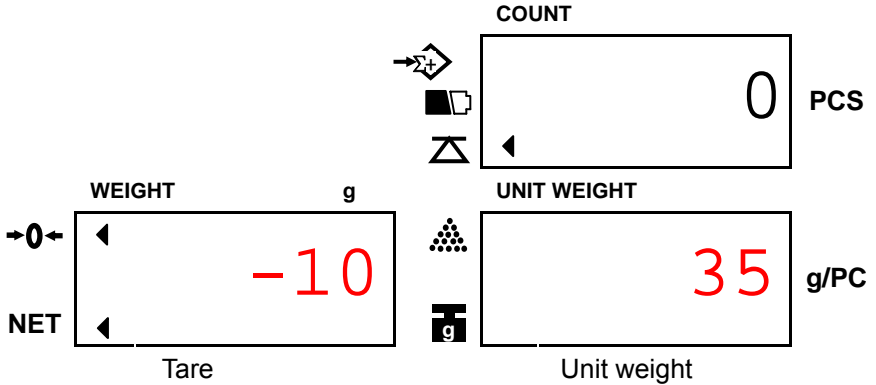

- Note:** 1) Place parts on the pan, you will know the number of parts.
 2) Press the **CLEAR** key to clear the current Unit Weight.
 3) Press the **U.WT** key during recall memory (Ex. address number 100) to check the item number.

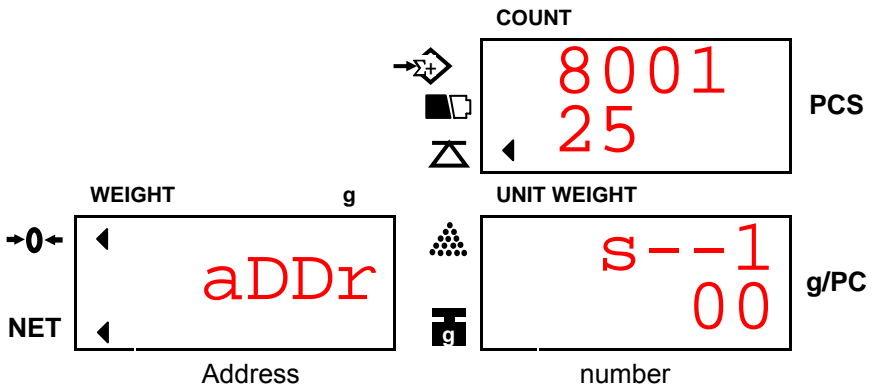

Remark: When the Alarm Setting is set during in the Recall Memory Mode, the Item Number and PLU Number can not be recalled.

(V) Subtract container's weight
weight unknown

1. Place a container on the pan.

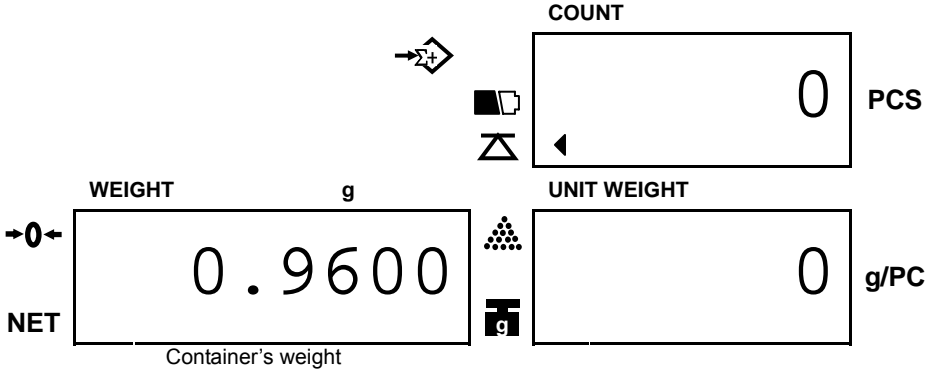

2. Press **TARE** key

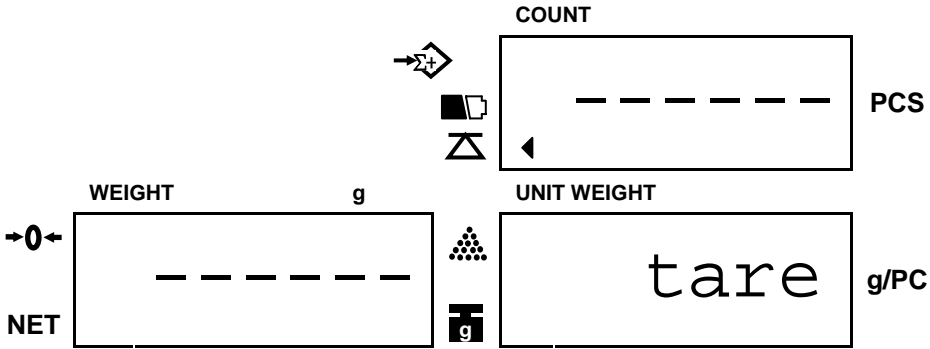

3. The scale will enter into counting mode while stable display appears as below.

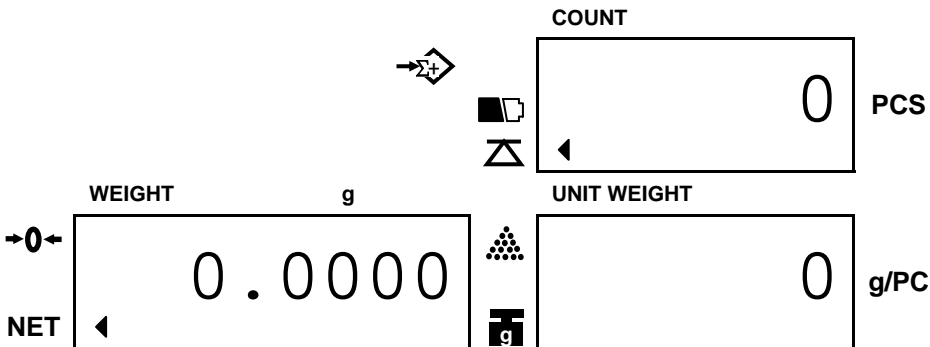

Container's weight known

1. Nothing on the pan

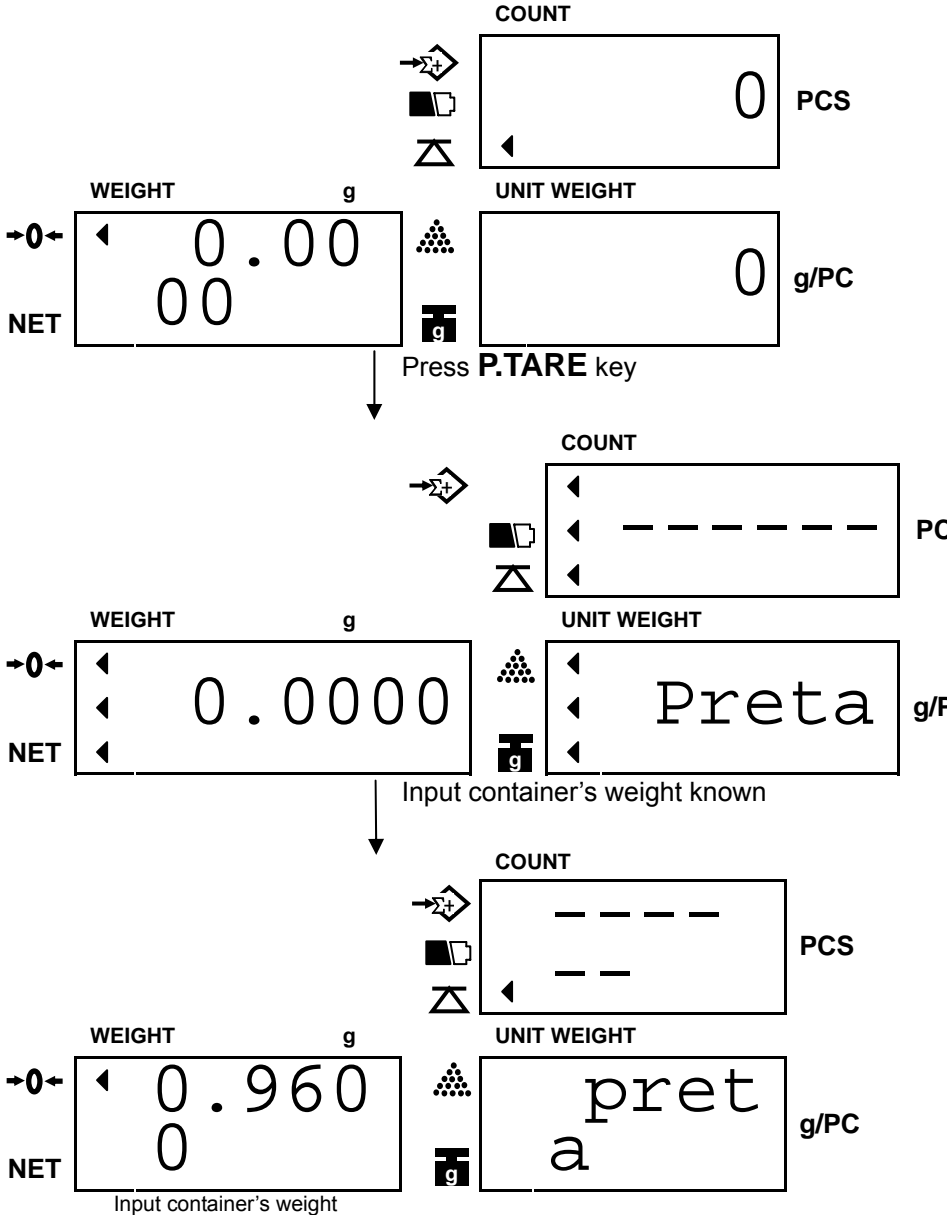

Press **P.TARE** key

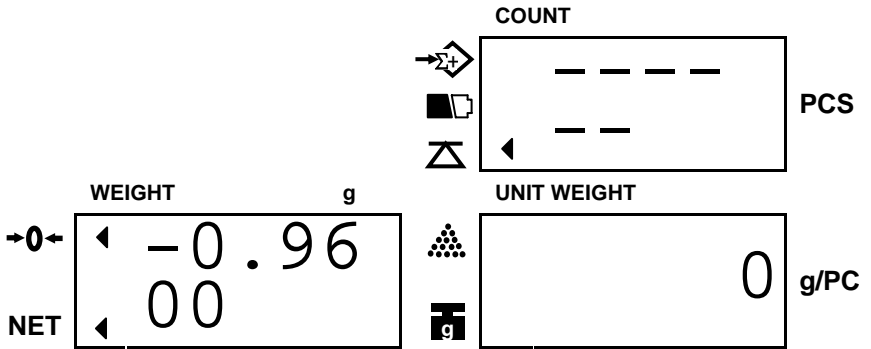

2. Scale is loaded

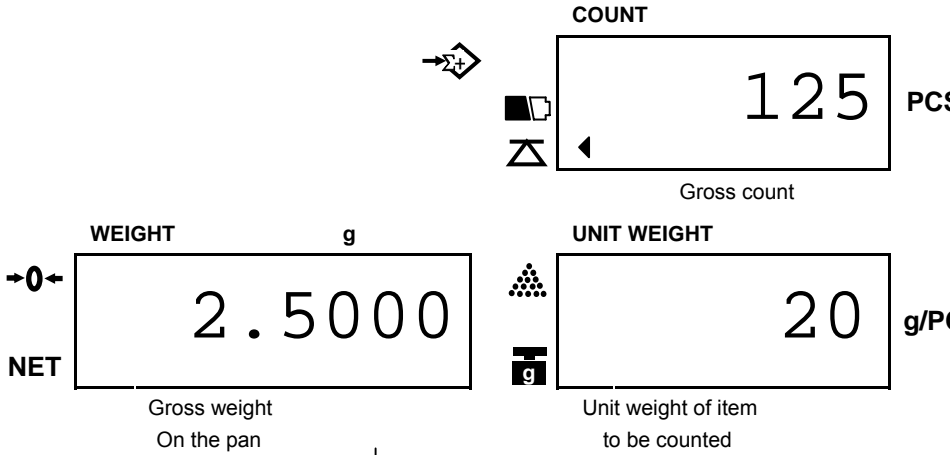

Press **P.TARE** key

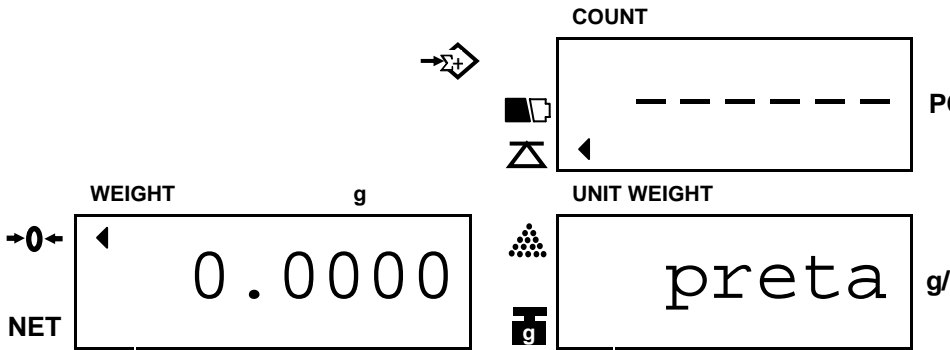

Input container's weight known

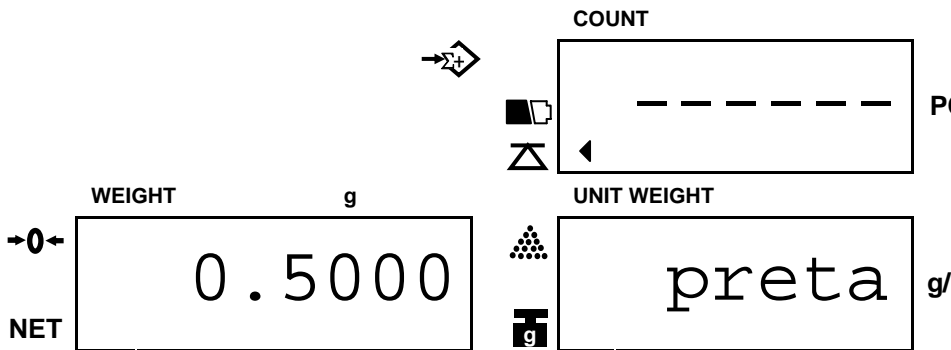

Press **P.TARE** key

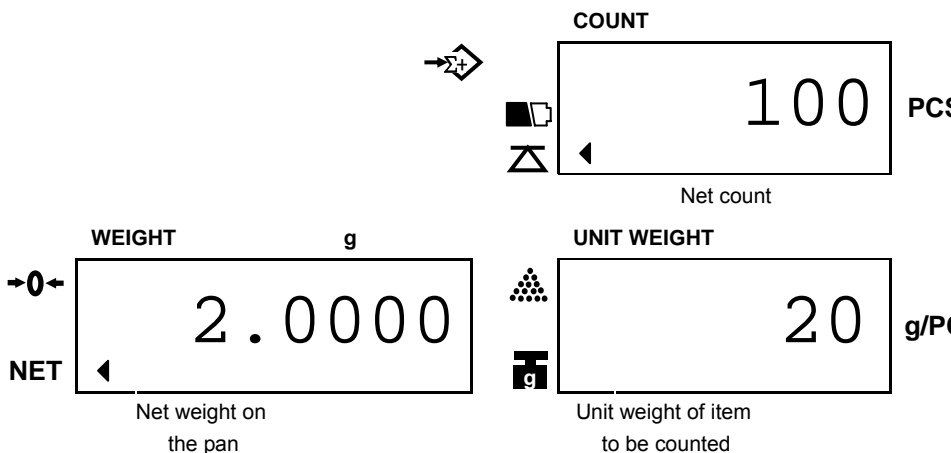

➡ Eliminate TARE

Remove all on the pan & the weight display will show a negative (-) container's weight. Pressing **TARE** key at this moment will bring the weight display to zero and TARE triangular indicator (◀) will disappear.

(VI) Weight/Quantity accumulation

1. Place item to be weighed/counted on the pan.

WEIGHT g

NET 1.0000

Weight on the pan

COUNT

5 PCS

UNIT WEIGHT

200 g/PC

2. Press **ADD** key.

WEIGHT g

NET ---

COUNT ---

PCS

UNIT WEIGHT

d ad g/PC

3. Display readings to be stable as below.

WEIGHT g

NET 1.0000

Total accumulated weight

COUNT

5 PCS

Total accumulated count

UNIT WEIGHT

≡ 01 ≡ g/PC

Total accumulation times

★ Accumulation effective only when stays at zero.

4. Press **TOTAL** key or wait approx. 2 seconds, the scale will return to counting mode.

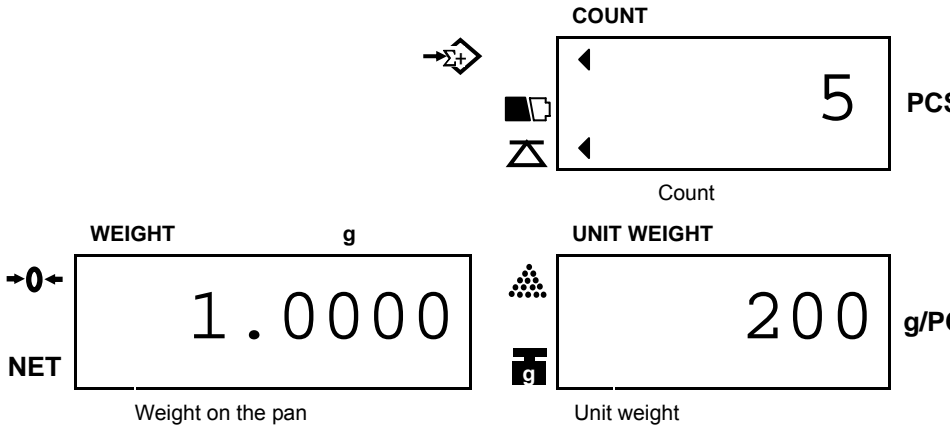

5. Press **TOTAL** key to enter into accumulation status mode.

At this moment, total accumulated weight is shown in WEIGHT window, total accumulation times is shown in UNIT WEIGHT window and TOTAL PIECES window displays accumulated count.

Press **TOTAL** key again to revert to counting mode.

➡ **Clear accumulation**

Press **TOTAL** key to enter into accumulation status mode and press **CLEAR** key to clear all accumulated data.

(VII) Preset counting check range

Users can set a Hi – Lo range for counting check, when the number of objects on the pan is within the preset counting check range, the alarm will sound beeps repeatedly.

Procedures

1. Press **ALARM** key while the scale is either loaded or unloaded.

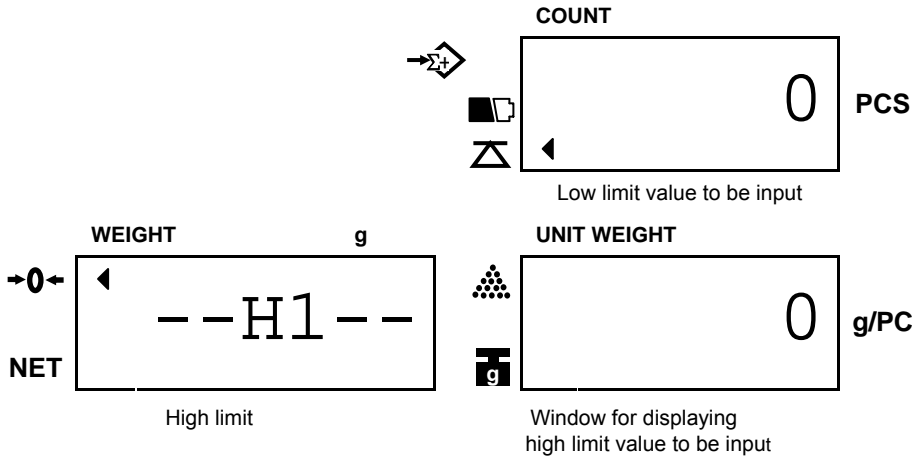

2. Key in the desired high limit value.

(use **CLEAR** key to erase the value keyed in)

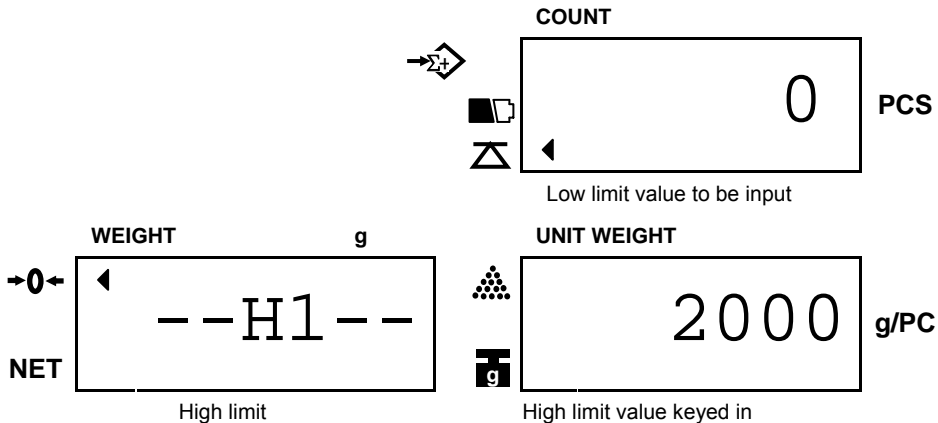

3. Press **ALARM** key again and key in the desired low limit value as indicated below. (Low limit value effective only after high limit is preset)

Diagram illustrating the keypad layout and display screens for setting limits:

- WEIGHT g**: Display shows **10**. Label: **Low limit**.
- COUNT**: Display shows **5**. Label: **PCS**. Label: **Low limit value to be input**.
- UNIT WEIGHT**: Display shows **2000**. Label: **g/PC**. Label: **High limit value keyed in**.

4. Press **SMPL** key to complete counting check range preset procedure and return to normal counting mode.

Diagram illustrating the keypad layout and display screens after setting limits:

- WEIGHT g**: Display shows **0.00**.
- COUNT**: Display shows **0**. Label: **PCS**.
- UNIT WEIGHT**: Display shows **0**. Label: **g/PC**.

Note: An error message “E5” appears When the LO value is set higher than HI value.

(VIII) Preset weight check range

Users can set a Hi – Lo range for weight check when the weight of objects on the pan is within the preset weight check range, the alarm will sound beeps repeatedly.

Procedures

1. Press **ALARM** key while the scale is either loaded or unloaded.

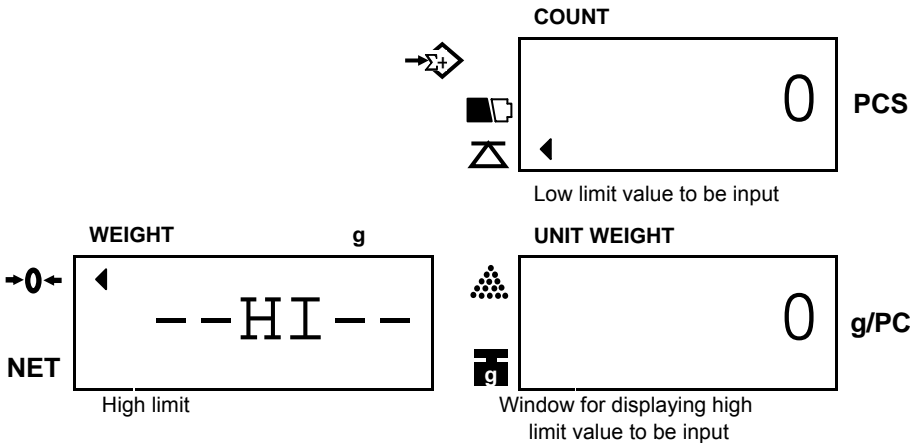

2. Key in the desired high limit value.

(Use **CLEAR** key to erase the value keyed in)

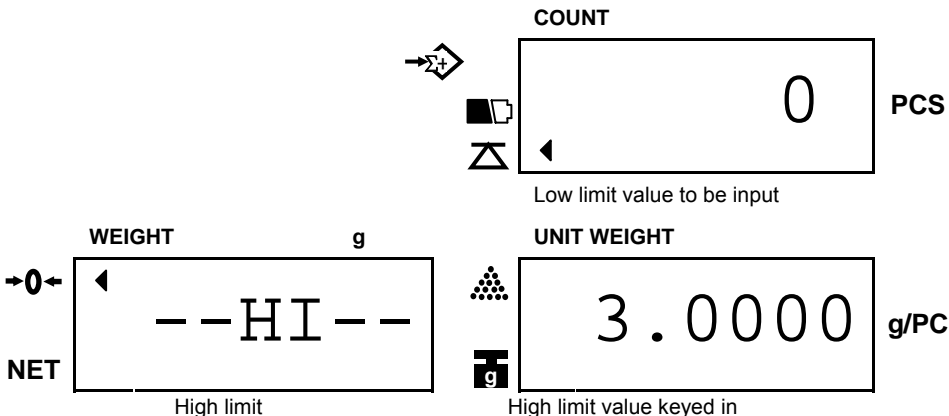

3. Press **ALARM** key again and key in the desired low limit value as indicated below.

(low limit value effective only after high limit is preset)

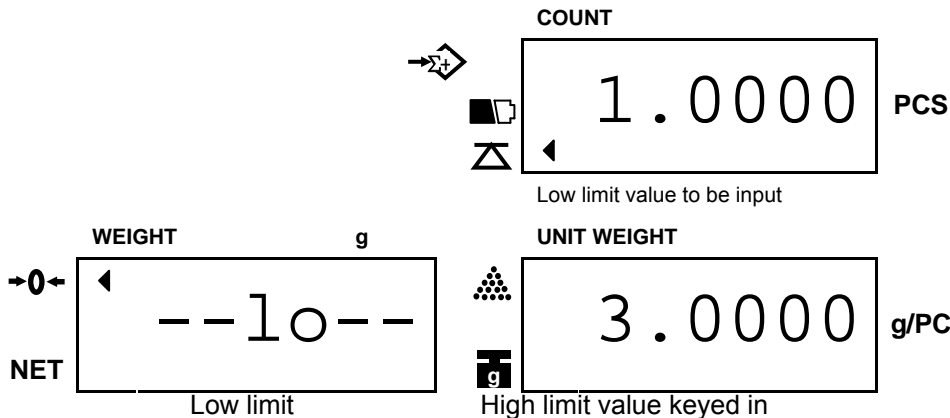

4. Press **U.Wt** key to complete weight check range preset procedures and return to normal counting mode.

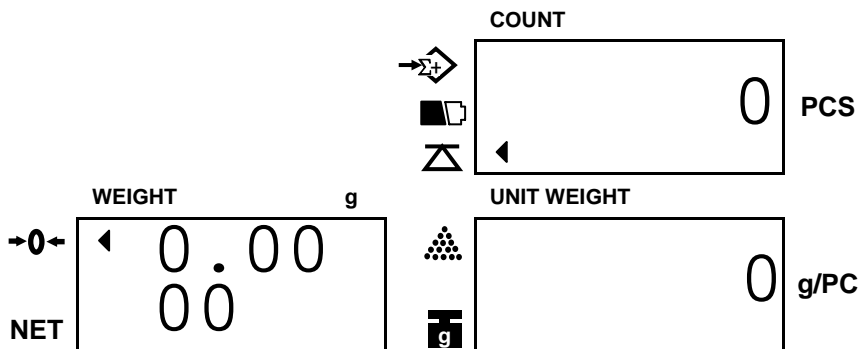

Note: An error message "E5" appears When the LO value is set higher than HI value.

➔ Clear high / low value preset

Follow the above preset procedures and key in " 0 " or press **CLEAR** key directly for high and low limit value.

V. User Programming Functions

In counting mode, press **SET** key to enter into USER PROGRAMMING FUNCTION MODE. After pressing “SET” key, the display shows “PASS WORD” to prompt to key in a pass word “101010” , then press “Enter” key to confirm the pass word. If the pass word is wrong, then the scale can not to enter into User Programming Function Mode.

The display shows “error” to prompt the mistake when the pass word is wrong.

If wrong pass word is entered for two times, then the scale will return to counting mode automatically.

(I) Auto. shut off time span

1. When enter into “User Programming Functions” mode, the displays will indicate as below eventually.

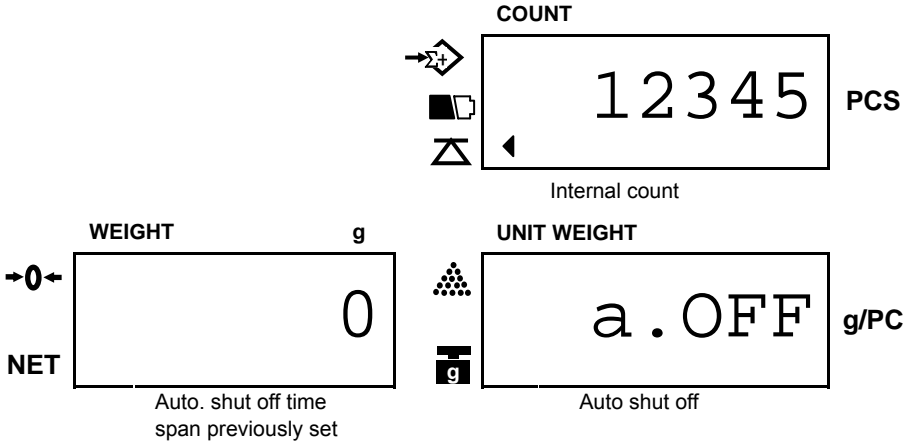

2. Press **MOVE** key to revolve the system-preset time span (2 min., 5 min., 8 min., and 0),
3. Press **CLEAR** key to determine and return to normal counting mode or press **ENTER** key for determination and move to next.

★ Turn off the scale to return to normal counting mode.

(II) Zero Tracking Range

1. Keep pressing **ENTER** key in USER PROGRAMMING FUNCTION MODE and release until the following displays appear.

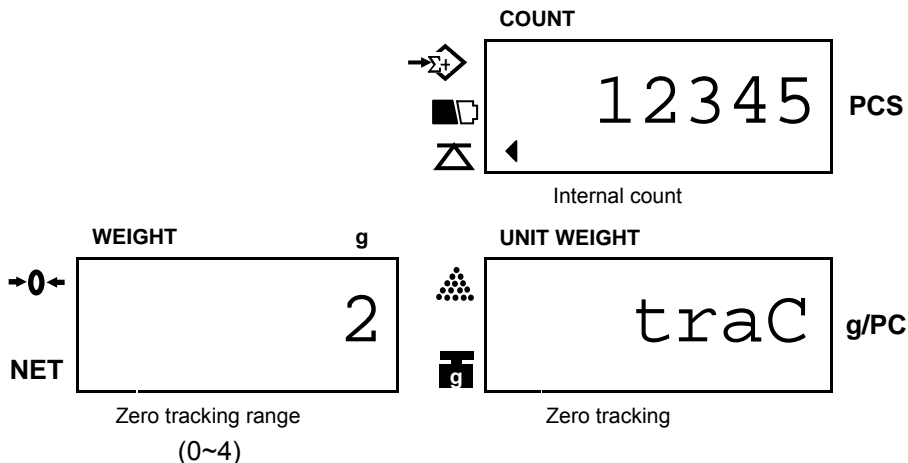

2. Press **MOVE** key to revolve the system-preset zero tracking range (0=off, 1=0.5d, 2=1d, 3=2d, 4=3d). The larger number selected, the wider range.
3. Press **CLEAR** key to determine and return to normal counting mode or press **ENTER** key for determination and move to next.

★ Turn off the scale to return to normal counting mode.

(III) Zero display range

1. Keep pressing **ENTER** key in USER PROGRAMMIN FUNCTION MODE and release until the following displays appear.

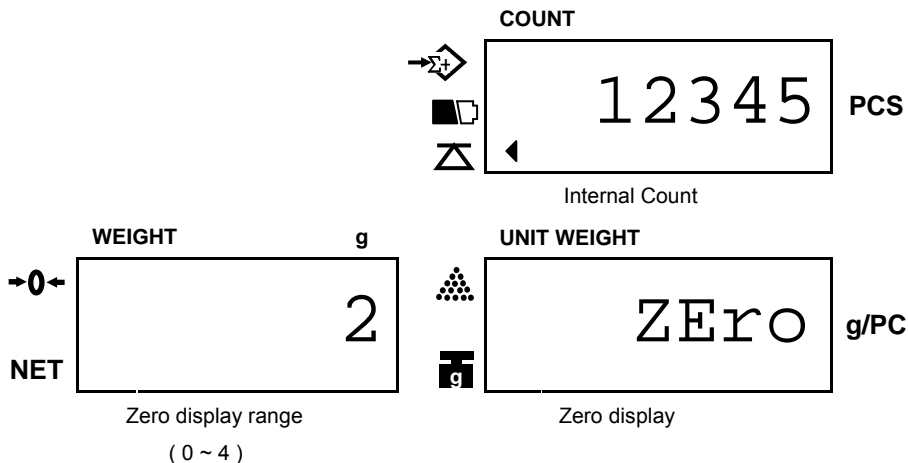

2. Press **MOVE** key to revolve the system-preset zero display range (0=off, 1=0.5d, 2=1d, 3=2d, 4=3d). The larger number selected, the wider range. Press **CLEAR** key to determine and return to normal counting mode or press **ENTER** key for determination and move to next.

★ Turn off the scale to return to normal counting mode.

(IV) Stable class range

1. Keep pressing **ENTER** key in USER PROGRAMMING FUNCTION MODE and release until the following displays appear.

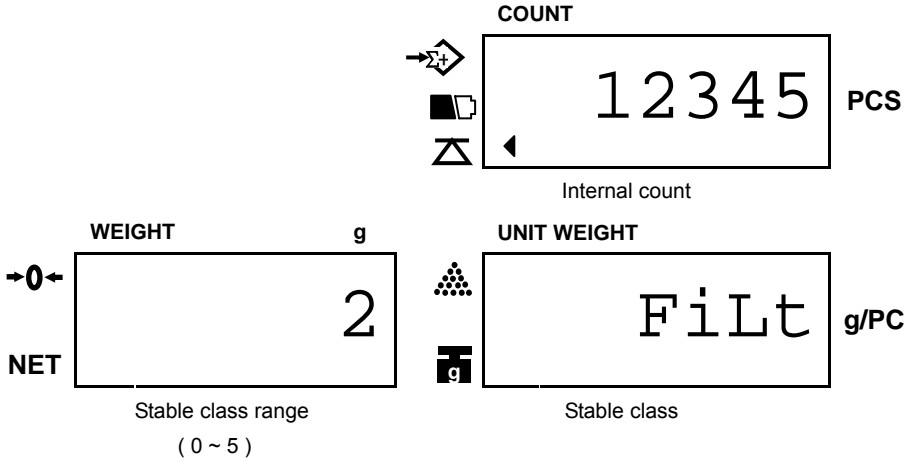

2. Press **MOVE** key to revolve the system-preset stable class range (0=off, 1=0.05d, 2=0.15d, 3=0.25d, 4=0.35d, 5=0.45d). The smaller number selected, the shorter time for display stability.
3. Press **CLEAR** key to determine and return to normal counting mode or press **ENTER** key for determination and move to next.

★ Turn off the scale to return to normal counting mode.

(V) Stable class rate

1. Keep pressing **ENTER** key in USER PROGRAMMING FUNCTION MODE and release until the following displays appear.

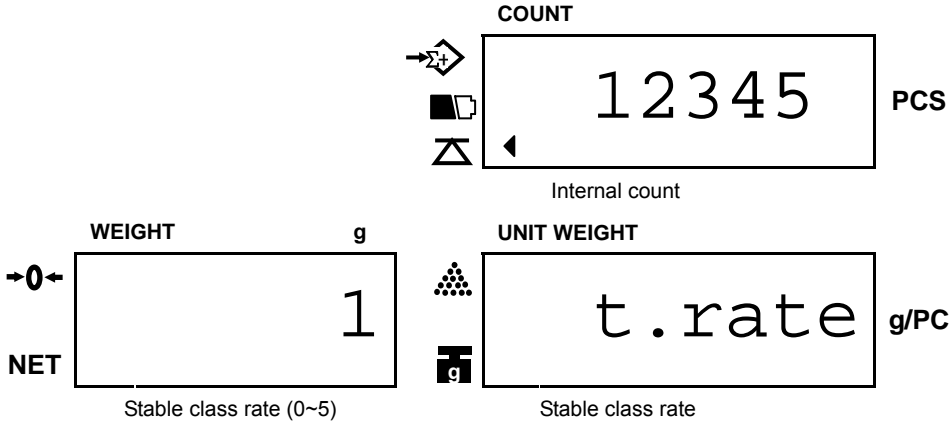

2. Press **MOVE** key to revolve the system-preset zero return class range (level: 0, 1, 2, 3, 4, 5). The larger number selected, the more stable zero point.
3. Press **CLEAR** key to determine and return to normal counting mode or press **ENTER** key for determination and move to next.

★ Turn off the scale to return to normal counting mode.

(VI) Backlight type

1. Keep pressing **ENTER** key in USER PROGRAMMING FUNCTION MODE and release until the following displays appear.

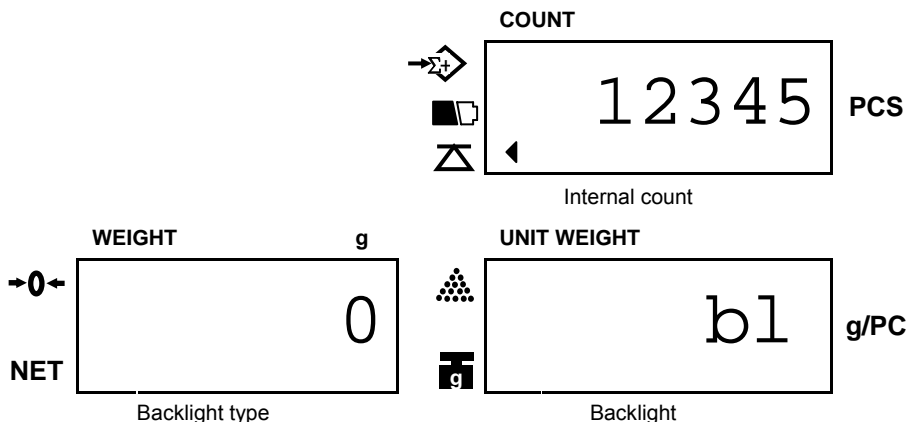

2. Press **MOVE** key to revolve the system-preset backlight type (0 – auto. backlight, 1 – manual backlight)
3. Press **CLEAR** key to determine and return to normal counting mode or press **ENTER** key for determination and move to next.

● Auto. Backlight

Backlight will be going on automatically whenever the scale is loaded by objects weigh greater than **9 display resolution** or any of keys is pressed. And it will be going off also automatically approx. 5 seconds after the scale returns to zero.

● Manual backlight

Press  (decimal point) key to switch on and off backlight.

- ★ Scale will keep the backlight type selected in memory for next use.
- ★ **Turn off the scale to return to normal counting mode.**

(VII) Change unit of measure from kg/g to Pound

1. Keep pressing **ENTER** key in USER PROGRAMMING FUNCTION MODE and release until the following displays appear.

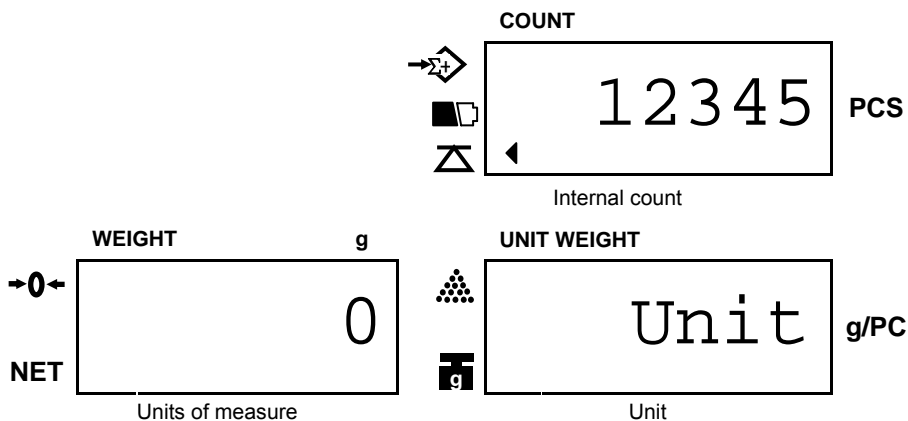

2. Press **MOVE** key to revolve the system-preset units of measure. (0 – kg or g , 1 – lb)
 3. Press **CLEAR** key to determine and return to normal counting mode or press **ENTER** key for determination and move to next.
- ★ Turn off the scale to return to normal counting mode.

(VIII) Unit weight recomputing

1. Keep pressing **ENTER** key in USER PROGRAMMING FUNCTION MODE and release until the following displays appear.

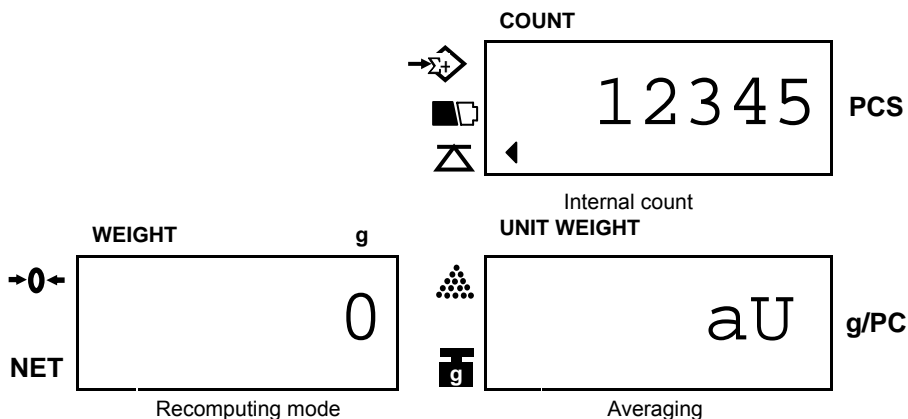

2. Press **MOVE** key to revolve the system-preset recomputing mode.
 - 0 – disable recomputing function
 - 1 – enable recomputing function
3. Press **CLEAR** key to determine and return to normal counting mode or press **ENTER** key for determination and move to next.

★ The unit weight will be averaged again if you add the remaining quantity, gradually, by several lots. This will help eliminate errors caused by the **possible weight variation among each object** and lead to more accurate results.

When adding objects to the pan (**The weight value should not be less than 10 display divisions.**), be sure that the quantity is LESS THAN those already on the pan. The alarm will sound a beep when the unit weight is averaged again.

- ★ Recomputing function effective only after sampling operation is done.
- ★ **Turn off the scale to return to normal counting mode.**

(IX) Check alarm type

1. Keep pressing **ENTER** key in USER PROGRAMMING FUNCTION MODE and release until the following displays appear.

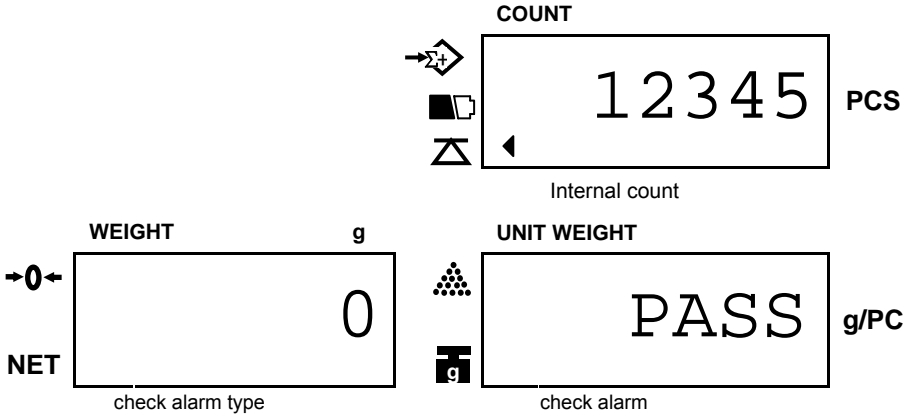

2. Press **MOVE** key to revolve the system-preset check alarm types.
0 – Inside type , 1 – Outside type
3. Press **CLEAR** key to determine and return to normal counting mode or press **ENTER** key for determination and move to next.

Inside type

The alarm sounds beeps only when either total weight or total count falls inside the set range.

Ex. 1 Counting check alarms

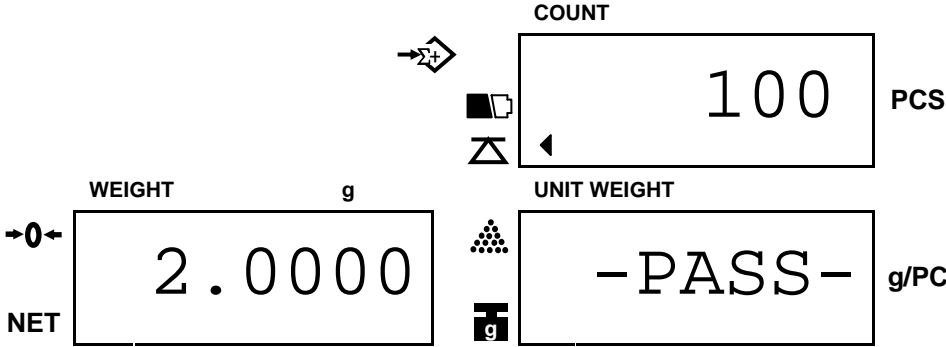

EX. 2 Weight check alarms

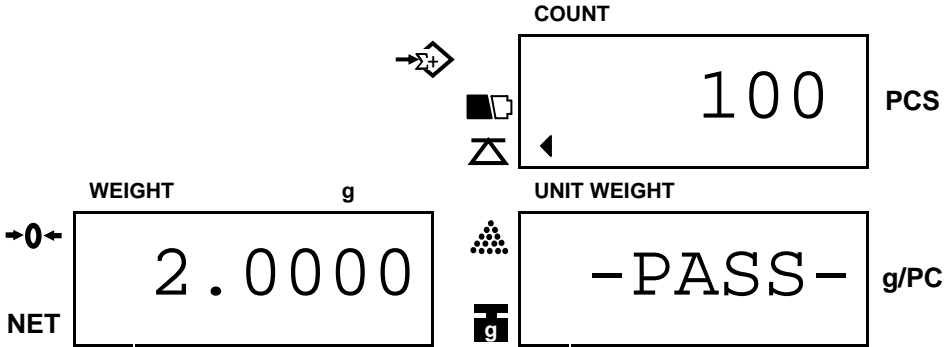

Outside type

The alarm sounds beeps only when either total weight or total count falls outside the set range.

Ex. 1 Counting check alarms

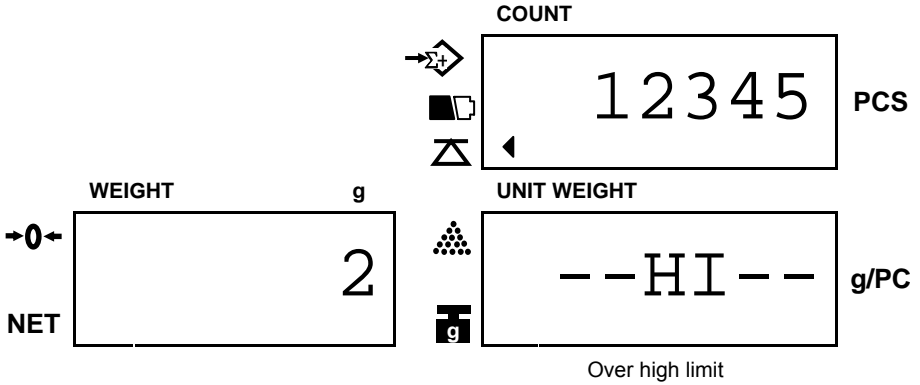

Ex. 2 Weight check alarms

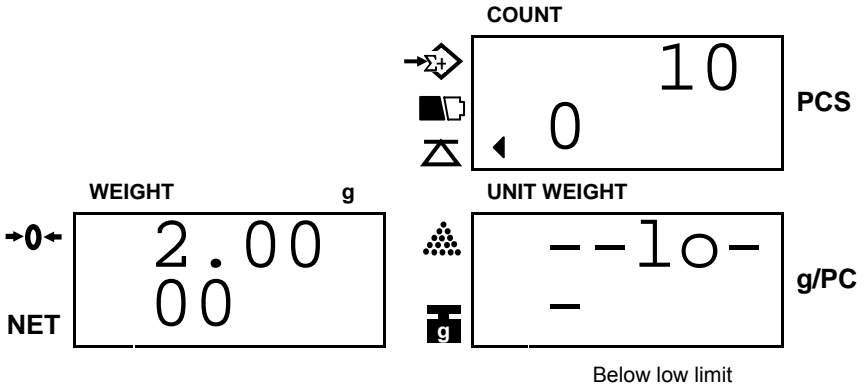

★ Turn off the scale to return to normal counting mode.

(X) Baud Rate setting

1. Keep pressing **ENTER** key in USER PROGRAMMING FUNCTION MODE and release until the following displays appear.

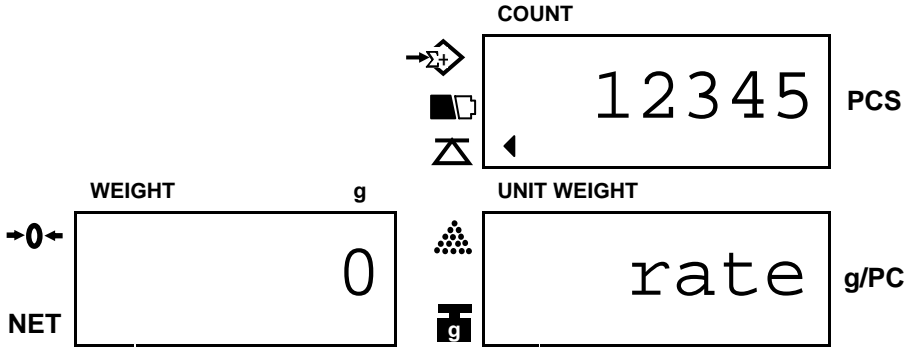

2. Press **MOVE** key to revolve the system-preset baud rate.
(0 – 2400 , 1 – 4800, 2-9600)
 3. Press **ENTER** key to determine and return to next setting.
- ★ Turn off the scale to return to normal counting mode.

(XI) Transmit method setting

1. Keep pressing **ENTER** key in USER PROGRAMMING FUNCTION MODE and release until the following displays appear.

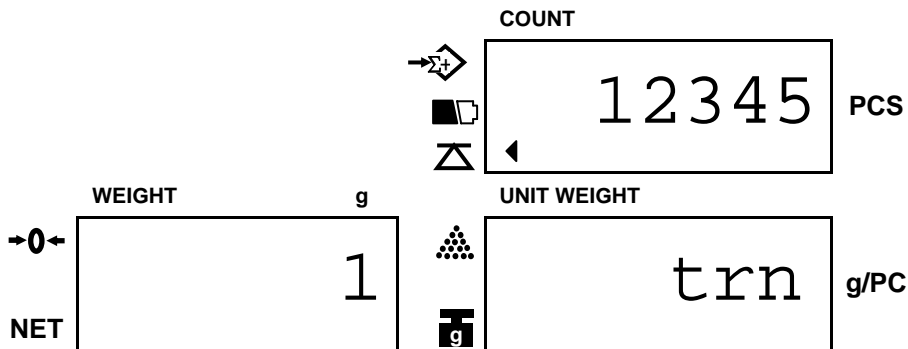

2. Press **MOVE** key to revolve the system-preset transmit method.

“1” = transmit by pressing a key

“2” = series transmit

“3” = transmit by pressing a key (for a label printer, such as: Model “DLP-50”)

“4” = auto-transmit (for a label printer, such as: Model “DLP-50”)

3. Press **ENTER** key to determine and return to next setting.

★ **Turn off the scale to return to normal counting mode.**

(XII) Label format setting (available when a label printer is connected.)

1. Keep pressing **ENTER** key in USER PROGRAMMING FUNCTION MODE and release until the following displays appear.

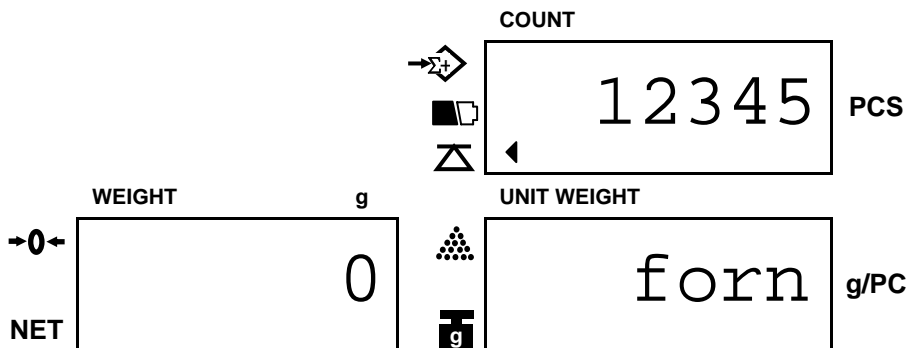

2. Press **MOVE** key to revolve the system-preset file name of the format. (form0~9)
3. Press **ENTER** key to determine and return to next setting.

★ Turn off the scale to return to normal counting mode.

(XIII) Cancel Tare setting

1. Keep pressing **ENTER** key in USER PROGRAMMING FUNCTION MODE and release until the following displays appear.

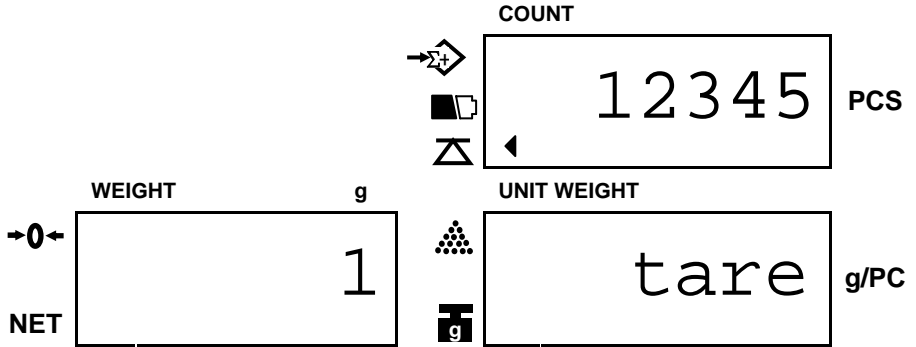

2. Press **MOVE** key to revolve the system-preset Cancel Tare mode.
 - “1” – The tare can be canceled continuously.
 - “2” – The tare must be canceled for one time only.(Note: If the canceled tare is not the value tared, then the buzzer will tweet to indicate the error. Turn off and turn on the solve the error.)
 3. Press **ENTER** key to determine and return to normal counting mode.
- ★ Turn off the scale to return to normal counting mode.

VI. Calibration (can be done in kg/lb)

1. Turn on the scale, and key in "000419" during counting down (self-check) to zero to enter into Simple Calibration mode.

The displays will indicate as below eventually. (Take 6kg scale for instance)

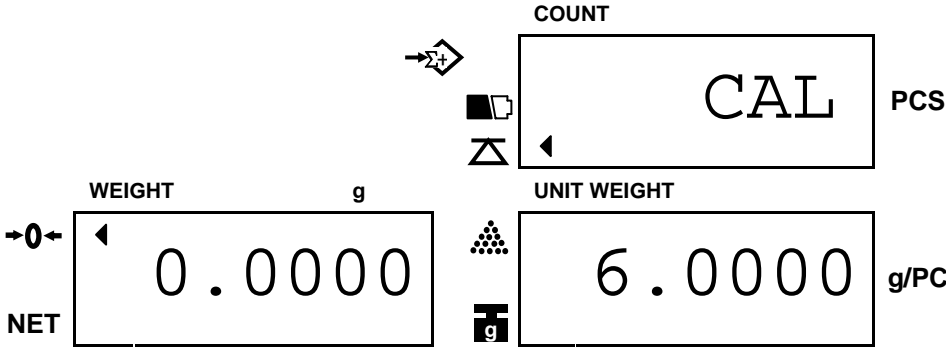

Required weight (6 kg) for calibration

2. Put a weight on the pan same as what exactly shown in the UNITWEIGHT window, then press the **ENTER** key to confirm the operation.

The displayed reading in the UNIT WEIGHT window starts blinking. The scale will stop blinking and return to normal counting mode.

Calibration is now completed.

- ★ Required weight for calibration can be changed by using numeric keys before step 2 above.
- ★ Press **CLEAR** key to escape from calibration mode at any time.

VII. Power supply & battery operation

POWER SUPPLY

- AC Adaptor
- DC 12V/800mA or 12V/1000 mA

BATTERY OPERATION

The scale can be operated from the battery if desired. The battery life is approximately 80 hours.

When the battery needs charging a symbol “” on the COUNT display will turn on. The scale can keep operating for about 10 hours when the symbol appears. The scale will automatically switch off to protect the battery. Before switching off automatically, a prompt words “Lobat off” will be shown three times to indicate the scale switch off due to battery empty.

To charge the battery, connect the power adapter, and turn on the switch on the right side of the scale.

The battery should be charged for 12 hours for full capacity.

There is an LED to indicate the status of battery charging on the display. If the LED is **Green** the battery has been charged. If it is **Red** the battery is nearly discharged and **Yellow** indicates the battery is increasing the charge level.

As the battery is used it may fail to hold a full charge. If the battery life becomes unacceptable then contact your distributor.

Note: The battery should be recharged every 3 months if the scale is not used for long time.

VIII.RS-232 Output

The scale can be ordered with as optional RS-232 output.

1. Mode E1A-RS 232C's UART signal
2. Format:

Baud rate: 9600 BPS
Data bits: 8 BITS
Stop bit: 1 BIT
Code ASCII
Connector:9 Pin Socket
Pin2 Input
Pin3 Output
Pin5 Signal Ground

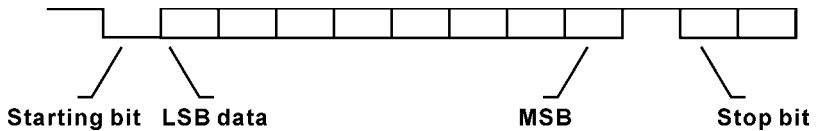

3. Data Format of Series transmit:

Net=Net Weight Pcs=Quantity U/W=Unit Weight
Tare= Tare

4. Transmit Format, when it is in Accumulation model and transmit by pressing "ADD" key and "TOTAL" key.

Press the **ADD** key

[100]

No. 800125

Record#01

Net: 2000.00 g

U/W: 10.0000 g

Pcs: 200

Tare: 35 g

Press the **ADD** key again

[100]

No. 800125

Record#02

Net: 3000.00 g

U/W: 10.0000 g

Pcs: 300

Tare: 35 g

Press the **TOTAL** key

[100]

No. 800125

Total

Net: 5000.00 g

U/W: 10.0000 g

Pcs: 500

Tare: 35 g

Note: When it is in normal counting model (without accumulation operation), press the “**TOTAL**” key to print the data, the transmit format is as below:

[100]

No. 800125

Total

Net: 5000.00 g

U/W: 10.0000 g

Pcs: 500

Tare:: 35 g

5. Format of Automatic and Series transmit without accumulation:

[100]

No. 800125

Total

Net: 5000.00 g

U/W: 10.0000 g

Pcs: 500

Tare: 35 g

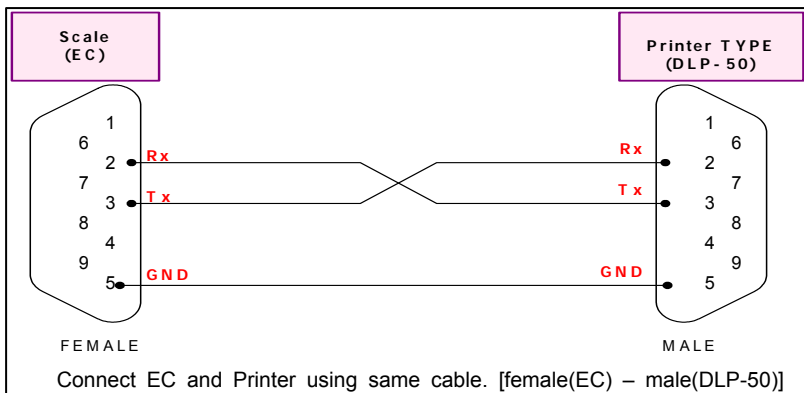

6. Variables (The prompt character) used in scale also in label printer

Variable Name	Specifications	Size
SER	Accumulated times (Weight)	2 byte
NWA	Net weight	7 byte
NWB	Net weight(no dot)	6 byte
TWA	Tare weight	7 byte
TWB	Tare weight (no dot)	6 byte
GWA	Gross weight	7 byte
GWB	Gross weight (no dot)	6 byte
TNA	Total net weight	7 byte
TNB	Total net weight(no dot)	6 byte
UWA	Unit weight	7 byte
UWB	Unit weight (no dot)	6 byte
QUA	Quantity	7 byte
QUB	Quantity (no dot)	6 byte
TQA	Total Quantity	7 byte
TQB	Total Quantity (no dot)	6 byte
UNT	Weighing Unit	2 byte
AN	Address number	3 byte
IN	Item number	6 byte

- Note:** 1) Capital Letters are allowed for the Variable Name only.
 2) A value “0” will be given when the value exceeds the display range.

IX. Error Codes

During the initial power-on testing it is possible the scale may show error message.

The meaning of the error messages is described below.

ERROR CODE	POSSIBLE CAUSES	HANDLING
E1,E2,E3	1.The scale pan is placed incorrectly.	Place the scale pan correctly.
	2.Turn on scale with something on the scale pan.	Take away the goods, and switch on again.
E4	Address code of Unit Weight is out of “1~200”.	Correct the operation.
E5	In alarm setting, the LO value is set higher than HI value.	Correct the operation.
OL	Overload	Take off the weight immediately.

If the error message still is shown after above ways, please recalibrate. If the problem still can not be solved then contact your dealer for further support.

X. Technical Data

Capacity(g)		3000	6000	15000	30000
Readability(e=d)	High	0.1	0.2	0.5	1
	Low	0.2	0.5	1	2
External Resolution	High	1/30,000			
	Low	1/15,000	1/12,000	1/15,000	1/15,000
Internal Resolution		1/600,000			
Display Type		LCD			
Weight Units		kg or g, lb			
Zero Range		±2%			
Tare Range		Full Capacity by Subtraction			
Stabilization Time		≤2 seconds			
Operation Temperature		0°C ~ 40°C			
Humidity Range		≤90% relative humidity, non-condensing			
Power		AC Adaptor DC 12V/1A or 12V/800mA Internal rechargeable sealed acid battery			
Battery Life		80 hours continuous use with 12 hour recharge time			
Calibration		Automatic external with kg/g mass, factory calibration recovery			
Safe Overload Capacity		120% of capacity			
Product weight		4.5kg			
Dimension(mm)		360(W) x 360(D) x 106(H)			
Platter Size(mm)		304(W) x 220(D)			