

Platform Scale IGX/IGB Series

Kg/Lb Specification

Operation Manual

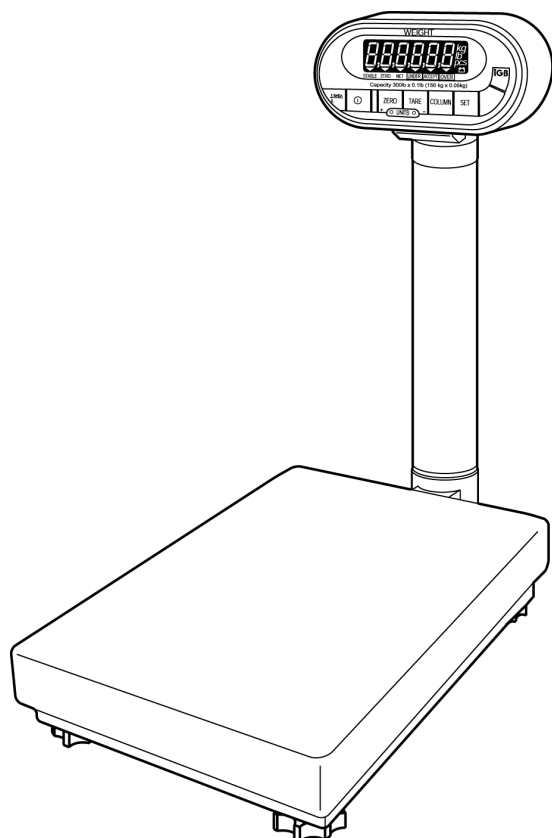

IGX Series

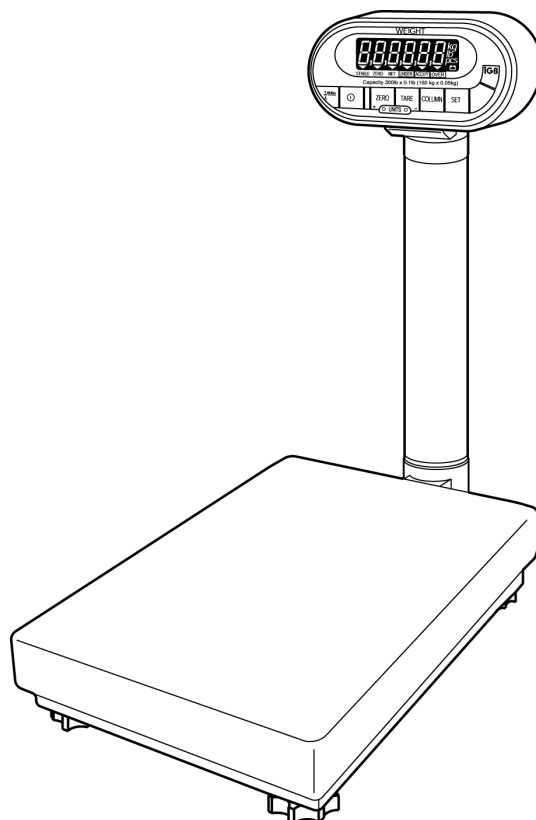

IGB Series

IMPORTANT

- Do not carry out installation, operation, service, or maintenance until thoroughly understanding the contents of this manual.
- Keep this manual available at all times for installation, operation, service, and maintenance.

ISHIDA CO., LTD.

PREFACE

Thank you for purchasing an Ishida IGX/IGB Series.

The IGX/IGB Series is a high-performance Platform Scale that weighs items precisely.

This manual explains the operation procedures, cautions for use, etc. of the IGX/IGB Series.

Please read this manual fully so that you can use the IGX/IGB Series safely and effectively.

Failure to follow the instructions in this manual may result in loss or serious injury, damage to the machine or faulty operation.

NOTE *This product cannot be used for certifying weight transactions.*

- No part of this manual may be reproduced in any form, by mimeograph or any other means, without written permission of the publisher.
- Design and specifications are subject to change without notice.
- There may be cases where the contents of this manual may not conform to the actual operations due to modifications to the machine or other reasons.
- Please convey your comments to your nearest Ishida dealer should you notice any errors or discrepancies in the contents of this manual.

Copyright © 2003 by Ishida Co., Ltd. All Rights Reserved.

No part of this manual may be reproduced in any form, by mimeograph or any other means, without written permission of the publisher.

CONTENTS

Chapter 1	BEFORE OPERATING MACHINE	1
1.1	Caution for Handling.....	2
1.2	Name and Function of Each Part	4
1.3	Installation	5
1.4	Start and Stop of Operation	7
1.5	Daily Care.....	8
Chapter 2	PRESET FUNCTION	9
2.1	Presetting the Values.....	10
2.2	Calling Up the Preset Values.....	14
Chapter 3	WEIGHING	15
3.1	Weighing Non-PLUs.....	16
3.2	Weighing PLUs.....	18
Chapter 4	SETTING MODE	21
4.1	Setting Method	22
4.2	Set Values List.....	24
Chapter 5	BATTERY CHECK	27
5.1	Checking Battery Voltage	28
Chapter 6	APPENDIX	31
6.1	Troubleshooting.....	32
6.2	Specifications	33

1

**BEFORE
OPERATING
MACHINE**

1.1 CAUTION FOR HANDLING

Safety Considerations

To ensure the safe operation of this machine, the general safety considerations below must be followed:

■Grounding

To avoid potential shock hazards, a protective grounding conductor for the machine must be securely connected.

■Do not disassemble or modify the machine

Doing so may result in physical injury or damage to the machine.

■Do not remove covers or housing

To avoid personal injury and shock, do not open or remove any covers or casing of the machine unless specified in this manual.

■Do not perform unspecified maintenance

For your own personal safety, do not perform any maintenance procedures which are not specified in this manual.

■Disconnect the power supply before servicing

To ensure your safety, disconnect the power supply before servicing.

Symbols Used in This Manual

This manual uses the following symbols to emphasize important information. Fully understanding the meaning of the symbols will facilitate the use of this manual.

Symbol	Meaning
	Indicates information that, if not heeded, could result in faulty operation, damage to the machine, or relatively serious injury.

Symbol	Meaning
NOTE	Indicates additional information of particular importance. Indicates information to help your understanding of the related text. Indicates a page to refer to.

Avoid Locating the Machine in the Following Places

A place subject to high temperature or high humidity.

A place exposed to direct sunlight or direct cold air.

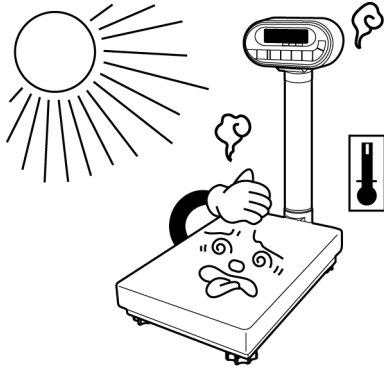

A place subject to strong wind.



A place where water or other liquids may be spilled on the machine.

A place subject to a lot of dust or dirt.



A place where the floor or ground is not level or unstable.



Power Supply

Always operate the machine with the specified AC voltage.

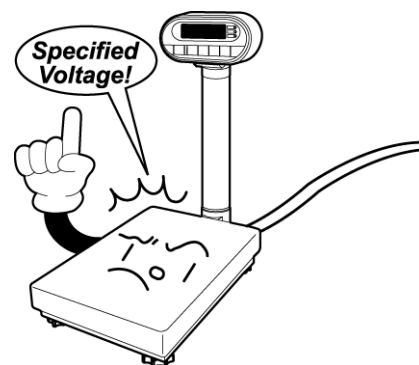

1.2 NAME AND FUNCTION OF EACH PART

■Appearance

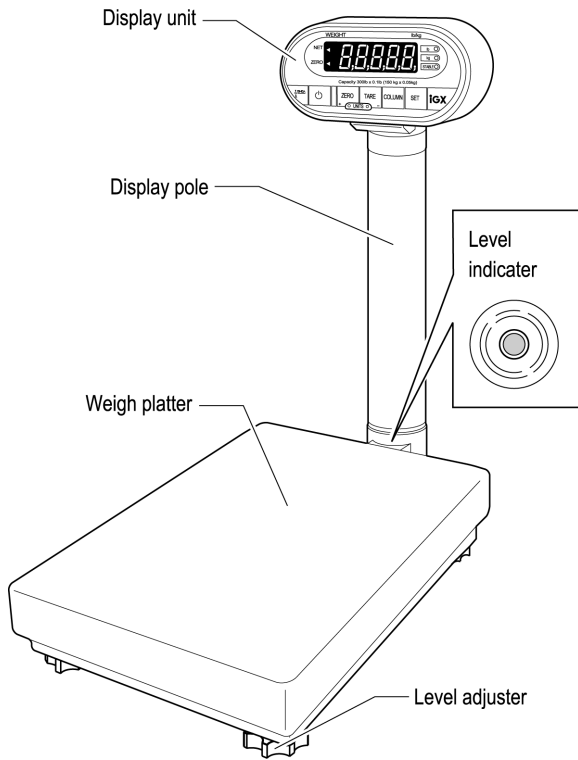

IGX Series

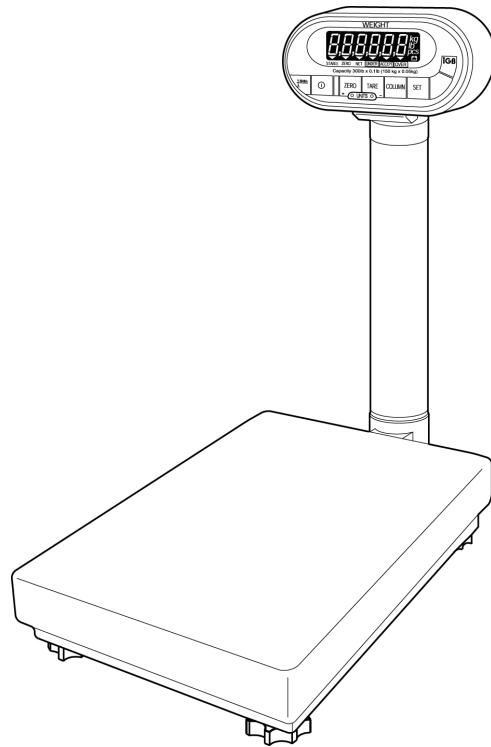

IGB Series

■Display Unit

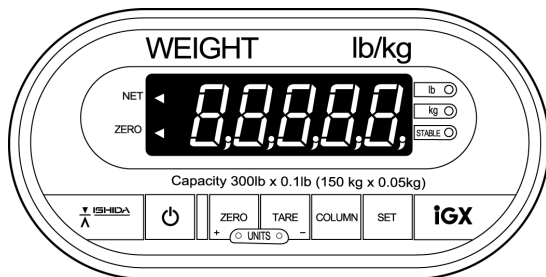

IGX Series

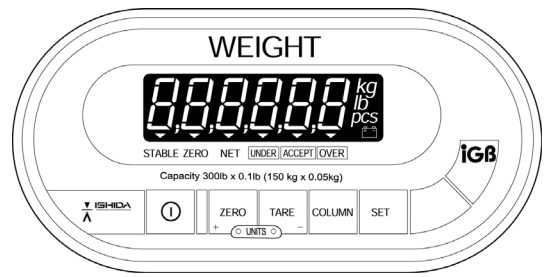

IGB Series



Used to turn the power on or off.



Used to set the scale weight to zero, or increase the value on the display.



Used to set the tare weight, or decrease the value on the display.



Used to move the digit position or finish a setting procedure.



Used to determine or call-up the setting.

1.3 INSTALLATION

1

BEFORE OPERATING MACHINE

Assembling the Scale

- 1 Remove the two hex-headed bolts from the bottom of the display pole.

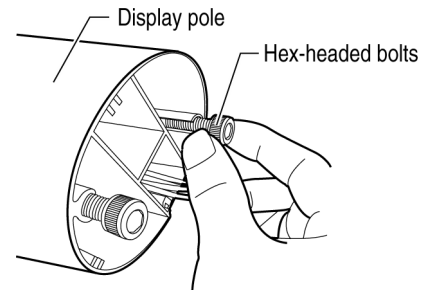

- 2 Carefully insert the bottom of the display pole into the base bracket while pulling out the slack in the cables.

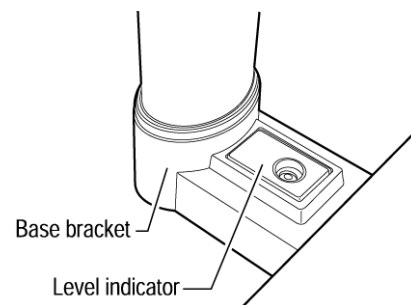

If the cable insulation is damaged, water may penetrate into the cable and cause inaccurate weighing, or the core material may corrode, causing the scale to fail.

- 3 Tighten the two hex-headed bolts with an Allen wrench.

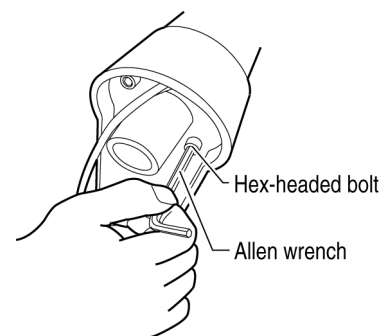

- 4 Bundle the excessive cables with a clamp so as to prevent cable damage.

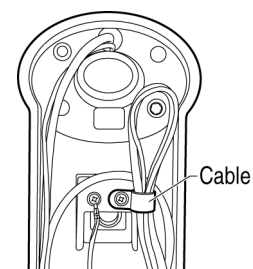

1.3 Installation

5 Carefully carry and place the Weigh Platter over the Platter Support.

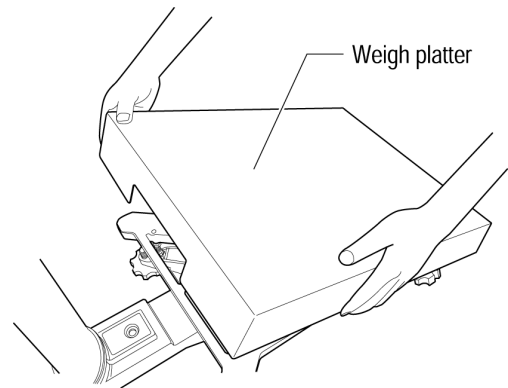

Leveling the Scale

Use the level adjuster until the air bubble inside the level is positioned in the center of the circle.

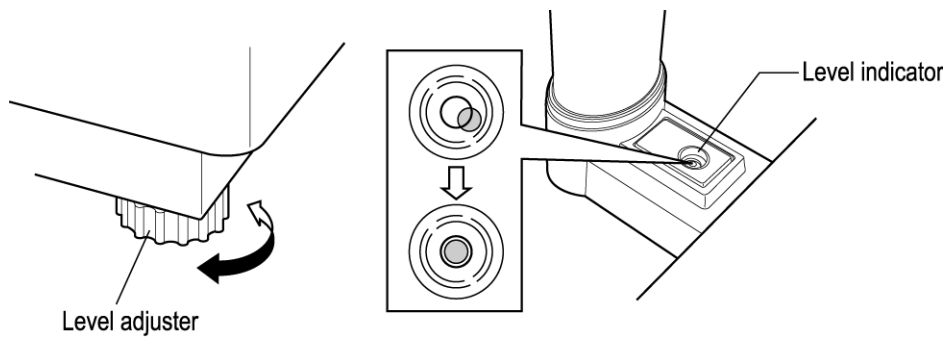

Adjusting the Display Unit Angle

After loosening the display unit tightening knob, adjust the unit to an easy-to see angle. Then re-tighten the knob.

Rear side of display unit

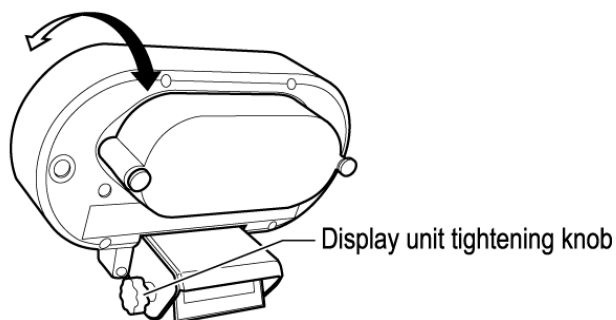

1.4 START AND STOP OF OPERATION

This section explains how to start and stop the machine operation.

Starting Machine Operation

- 1 Make sure that nothing is placed on the weigh platter.
- 2 Press the ON/OFF key to turn on the power. Then, the self-diagnostic display appears and all display segments are lit.

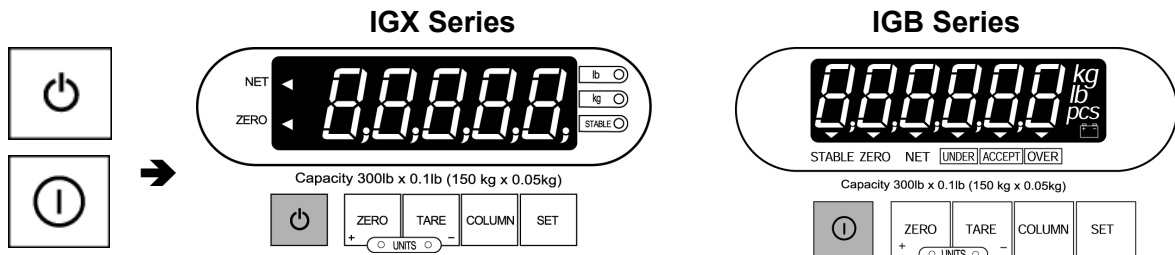

- 3 Make sure that the initial display appears and the “ZERO” indicator lights.

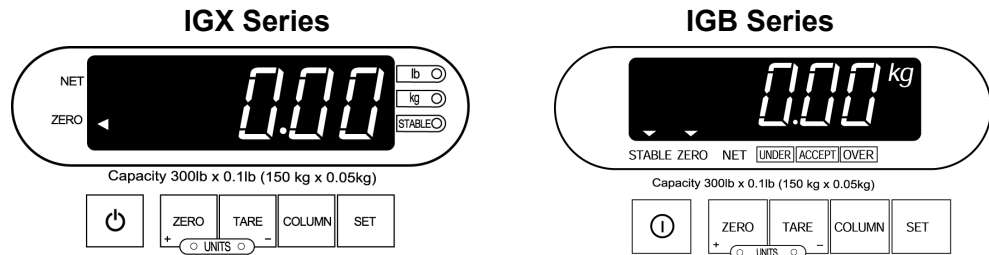

NOTE If the “ZERO” indicator is not lit, press the ZERO key.

Stopping Machine Operation

- 1 Press the ON/OFF key to stop the machine operation.

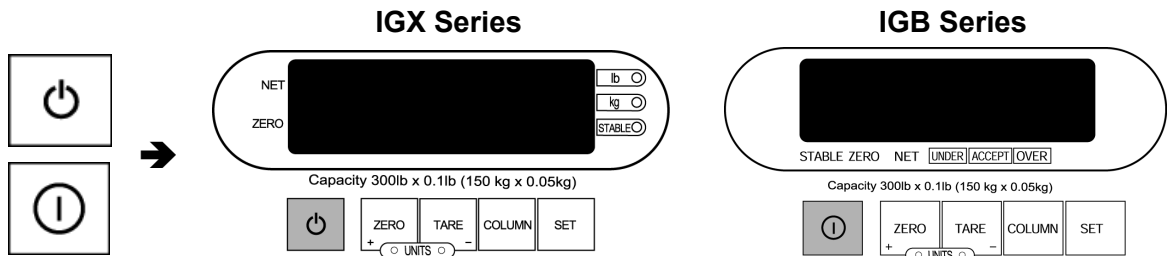

NOTE When the scale has not been used for a long time, the scale will be automatically turned off.

1.5 DAILY CARE

Daily care will ensure the long life of this machine, and can prevent potential trouble or failure. Also, cleaning the machine after operation is recommended.



To ensure your personal safety, disconnect the power plug from the outlet before any servicing or cleaning.

Clean the outer surface of the machine with a soft cloth soaked with a water-diluted neutral detergent. Then, wipe it with a soft and dry cloth.

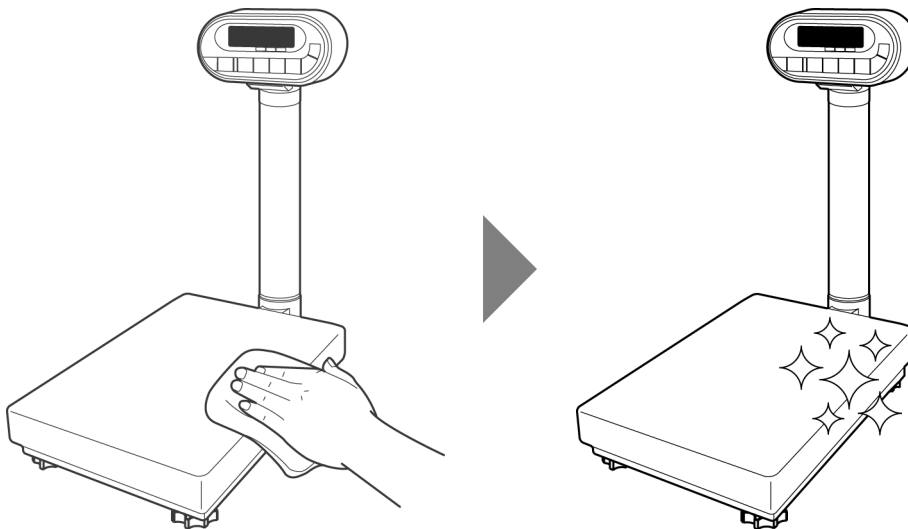

Do not use thinner or chemicals other than a water-diluted neutral detergent.

2

PRESET FUNCTION

2.1 PRESETTING THE VALUES

Selecting the PLU No.

1 When the power is turned OFF,

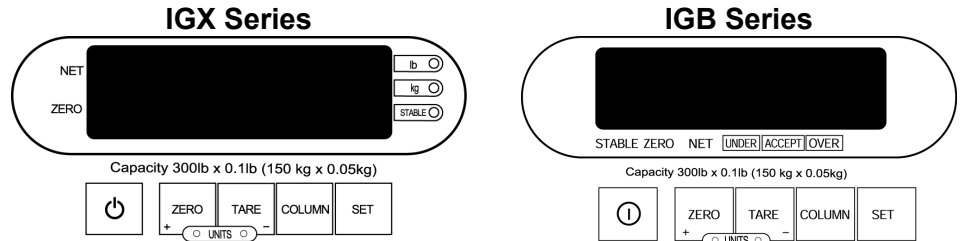

press the ON/OFF key, then the self-diagnosis display appears.

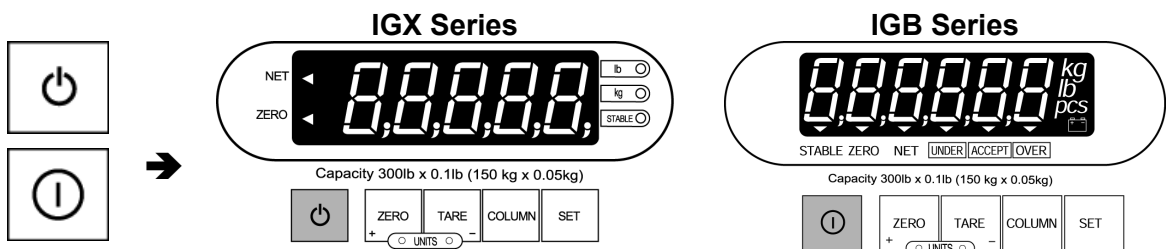

2 Immediately press the SET key while all display segments are lit. PLU 1 will be displayed.

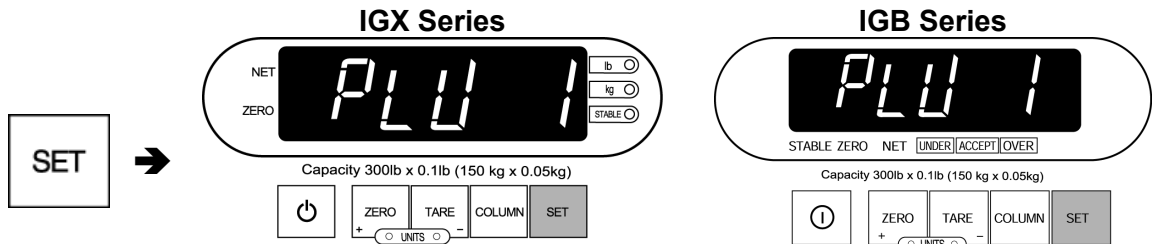

3 Repeat to press either the ZERO (+) or TARE (-) key until the desired PLU No. appears on the display.

[Example] Selecting PLU 2

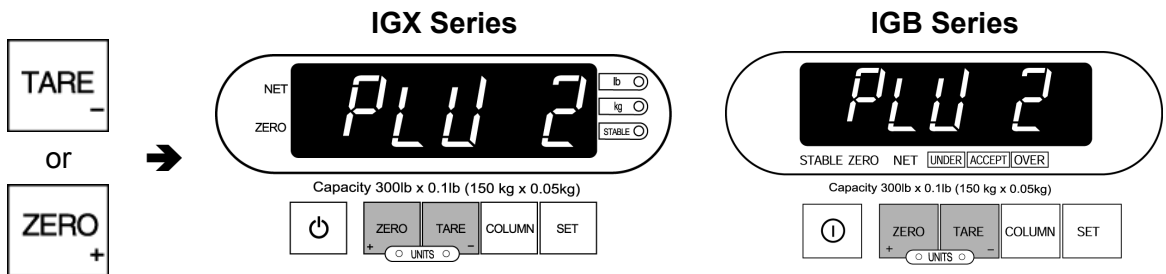

Setting the Tare Weight

4 Press the SET key to display the tare weight for the selected PLU.

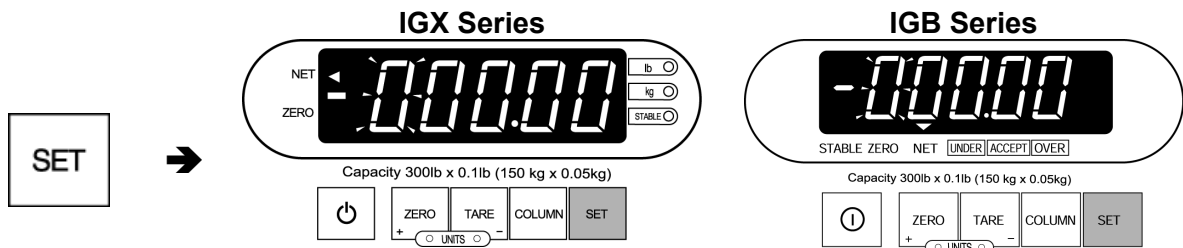

5 Move the flashing digit to the desired position by pressing the COLUMN key.

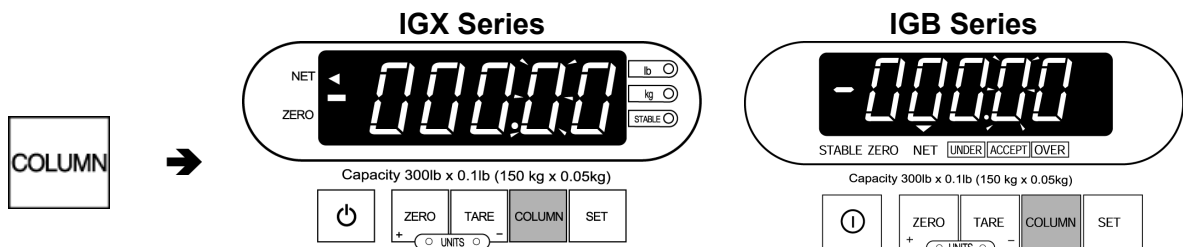

6 Increase or decrease the numeric value by pressing the ZERO (+) or TARE (-) key. Then, press the COLUMN key to determine the value. Repeat this step until completing the entry.

[Example] Tare weight 250g

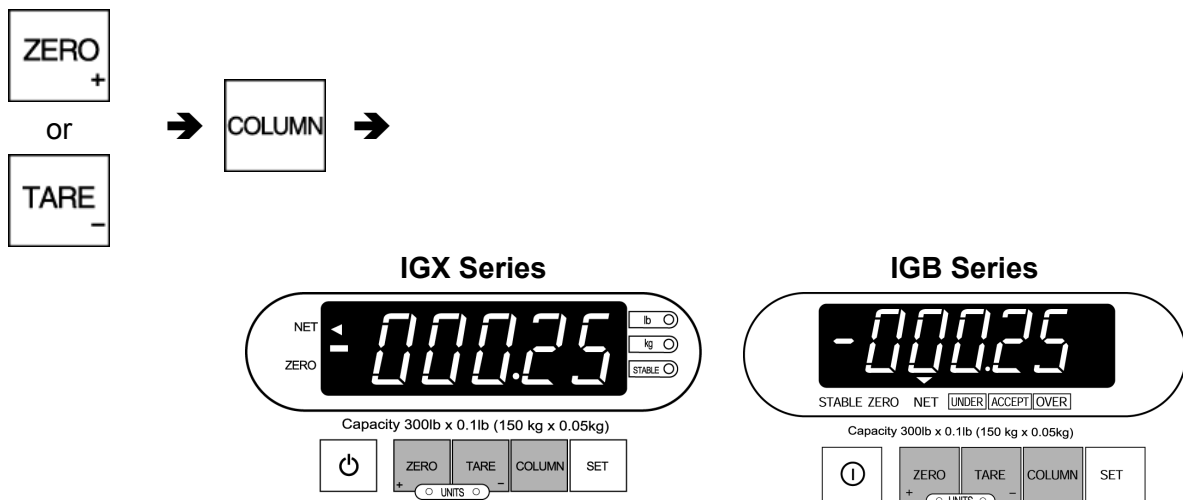

Setting the Upper Limit Value

7 Press the SET key to determine the tare weight and move to the display for setting the upper limit value. Move the flashing digit to the desired position by pressing the COLUMN key.

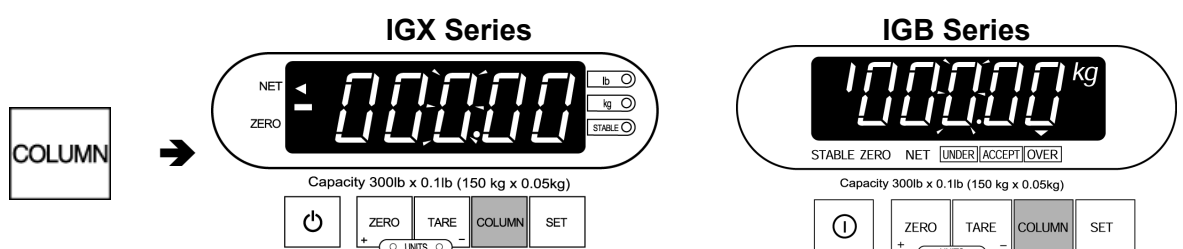

2.1 Presetting the Values

8 Increase or decrease the numeric value by pressing the ZERO (+) or TARE (-) key. Then, press the COLUMN key to determine the value. Repeat this step until completing the entry.

[Example] Upper limit value 1000g

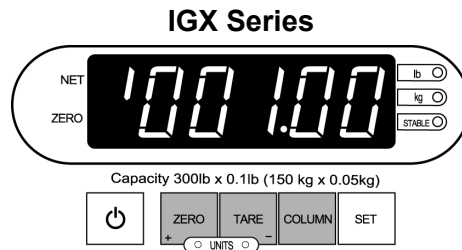
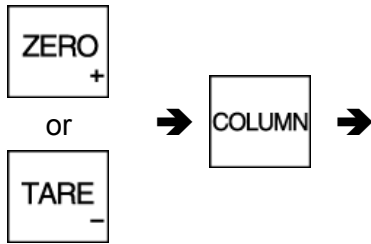

Setting the Lower Limit Value

9 Press the SET key to determine the upper limit value and move to the display for setting the lower limit value. Move the flashing digit to the desired position by pressing the COLUMN key.

NOTE If the lower limit value has already been preset, only a value equal to or larger than this limit value can be set.

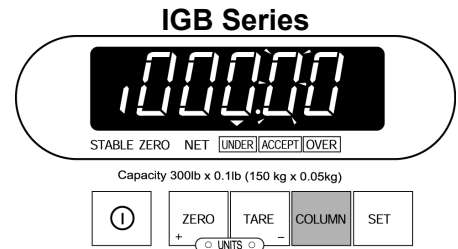
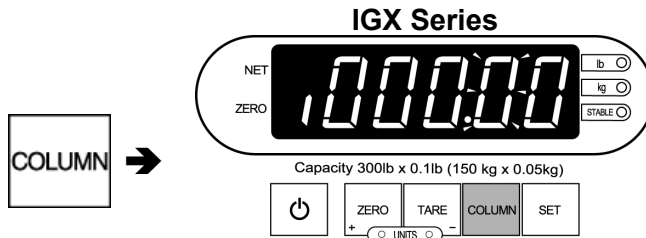

10 Increase or decrease the numeric value by pressing the ZERO (+) or TARE (-) key. Then, press the COLUMN key to determine the value. Repeat this step until completing the entry.

[Example] Lower limit value 500g

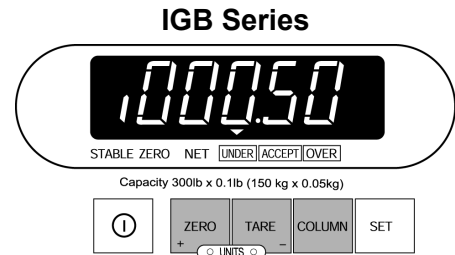
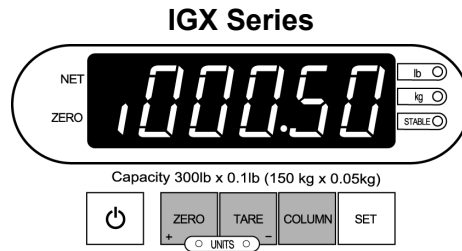
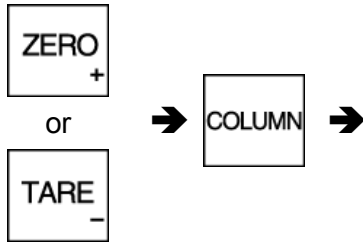

Setting Values for Other PLUs

11 Press the SET key to determine the lower limit value. Repeat steps 3 through 10 above for setting the values for other PLUs.

NOTE If the upper limit value has already been preset, only a value equal to or less than this limit value can be set.

Finishing the Setting Procedures

12 Press the COLUMN key to finish the setting procedure.

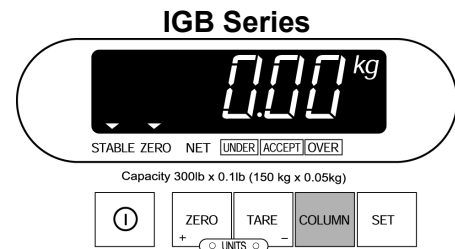
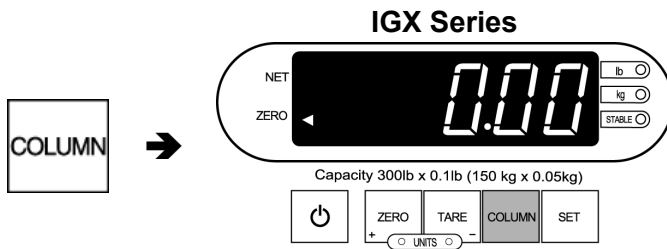

2.2 CALLING UP THE PRESET VALUES

- 1 Press and hold the SET key for two seconds.
“PLU 1” will be displayed.

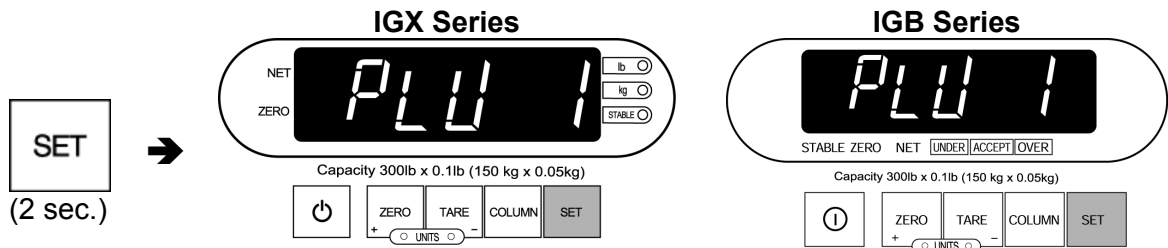

- 2 Press the ZERO (+) or TARE (-) key to select the desired PLU No.

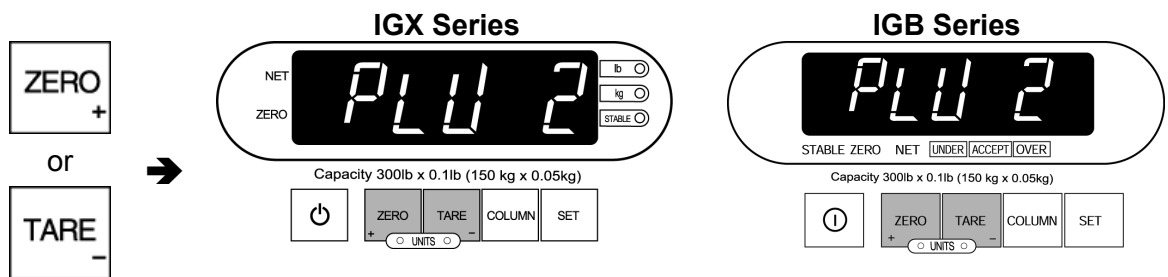

- 3 Press the SET key to display the tare weight, the upper limit value, and the lower limit value.

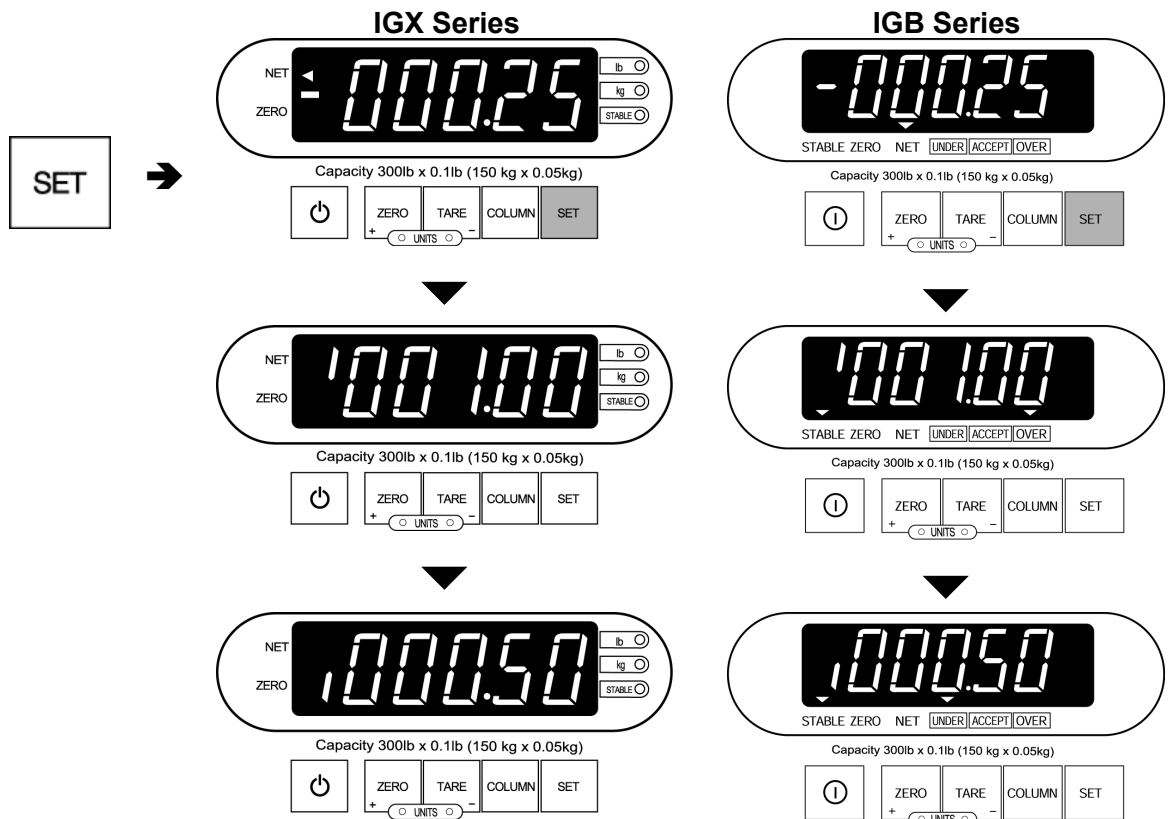

NOTE If no tare weight has been set, or if neither the upper limit value nor the lower limit value has been set, the values set before pressing the SET key will remain active.

3

WEIGHING

3.1 WEIGHING NON-PLUs

1 When the power is turned OFF,

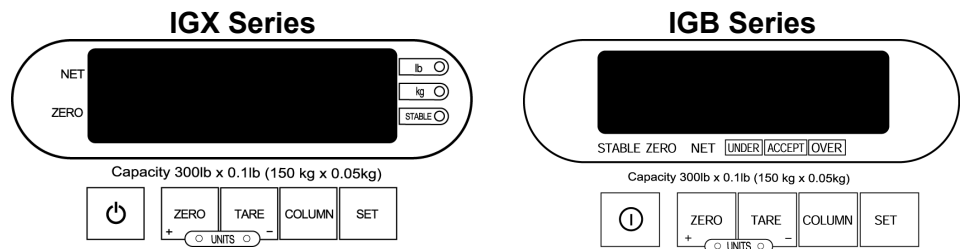

press the ON/OFF key to turn on the power, the self-diagnosis display will start, then stop at the initial display with “ZERO” indicator lit.

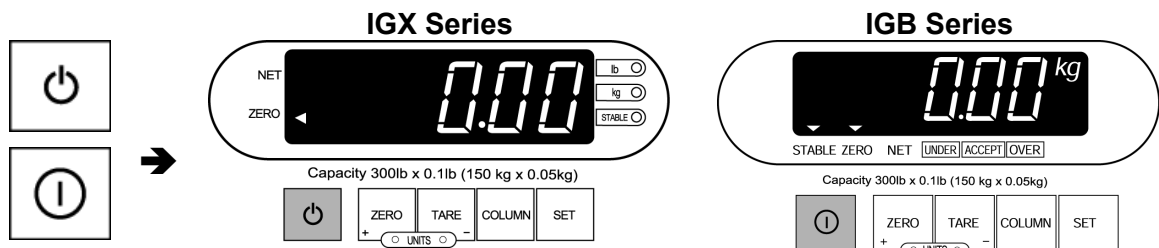

NOTE If “ZERO” indicator is not lit, press the ZERO key to initialize the display.

2 Place a tare on the weigh platter, and press the TARE key to subtract the weight. The “NET” indicator will be lit.

[Example] Tare weight: 180g

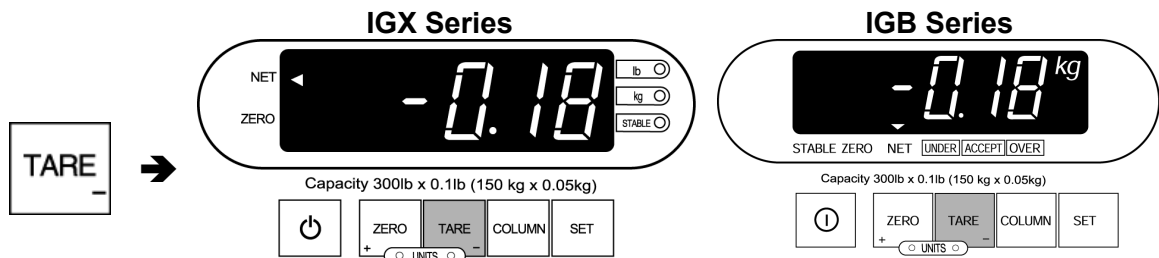

3 Place an item on the weigh platter. The display will show the net weight.

[Example] Net weight: 2,280g

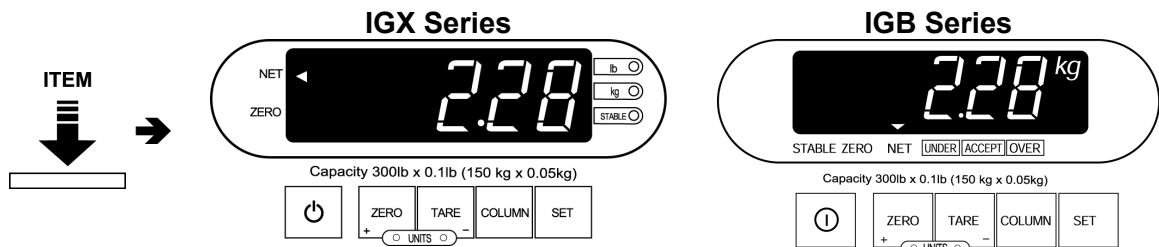

4 When setting “kg” or “lb” select the desired weight unit by pressing the ZERO key and TARE key at the same time.

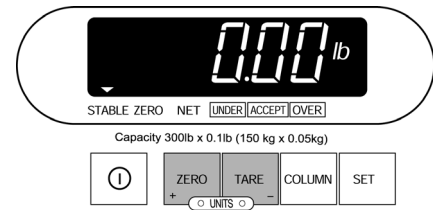
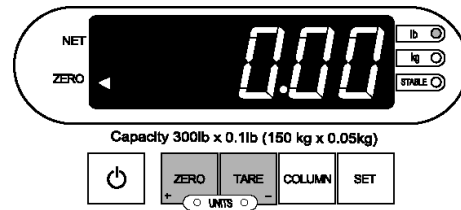
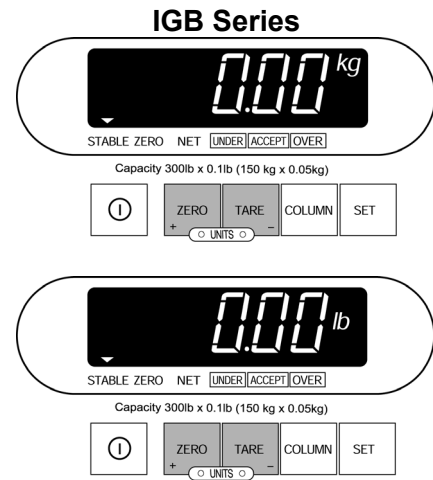
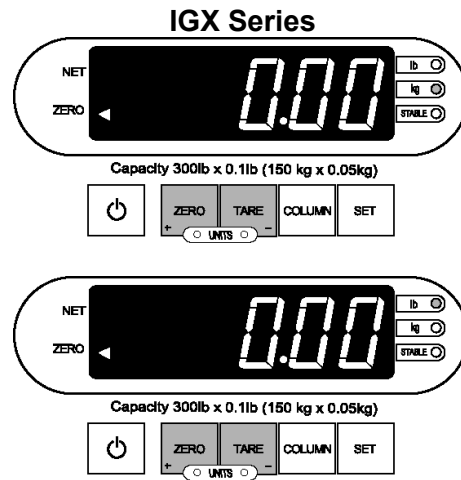
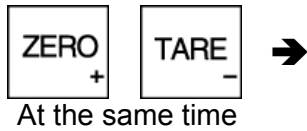

- NOTE**
1. Either “kg” or “lb” indicator will be lit.
 2. This function is available only when nothing is placed on the platter.

3.2 WEIGHING PLUs

1 When the power is turned OFF,

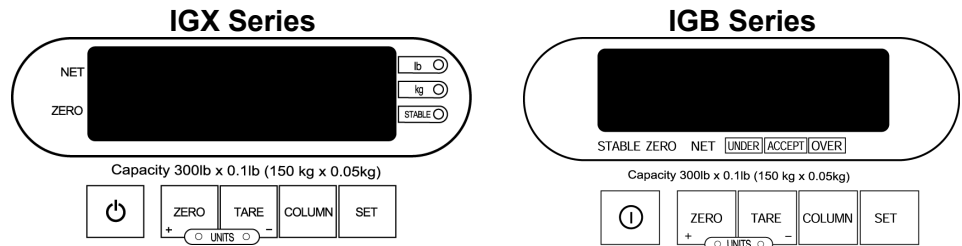

press the ON/OFF key to turn on the power, the self-diagnosis display appears, then stop at the initial display with “ZERO” indicator lit.

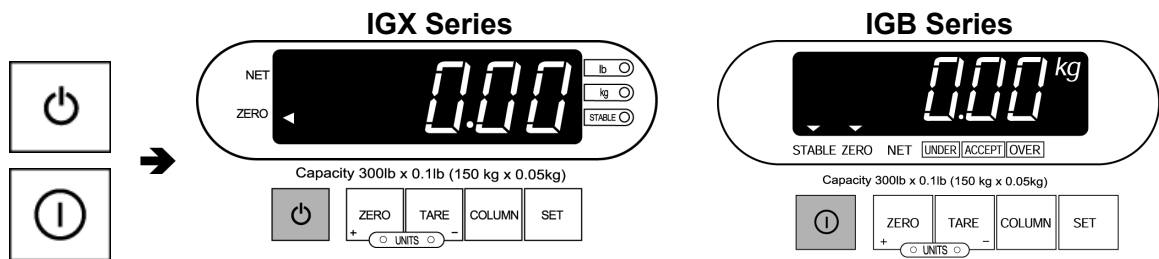

NOTE If “ZERO” indicator is not lit, press the ZERO key to initialize the display.

2 Press the SET key, then “PLU 1” appears on the display.

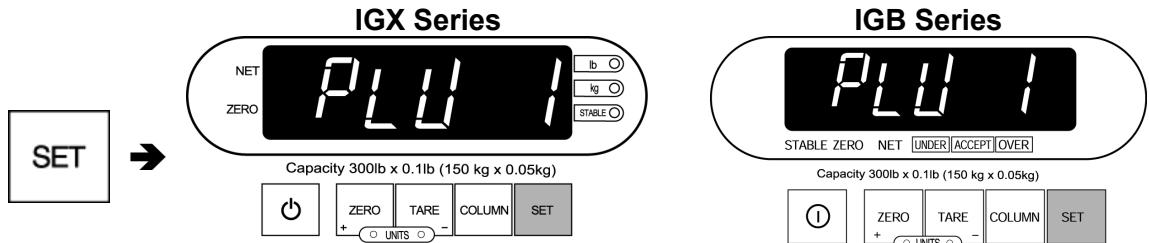

If necessary, repeat to press either the ZERO (+) or TARE (-) key until the desired PLU No. appears on the display.

[Example] Selecting PLU 2

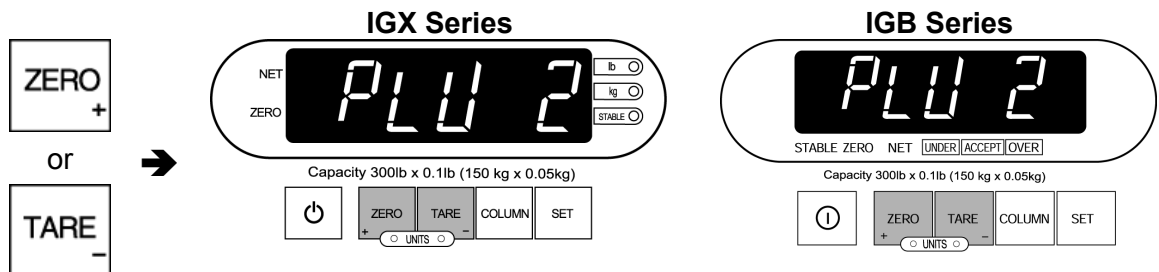

3 Press the SET key to display the tare weight, upper limit value, and lower limit value for the selected PLU.

[Example] Tare weight 250g
Upper limit value 1000g
Lower limit value 500g

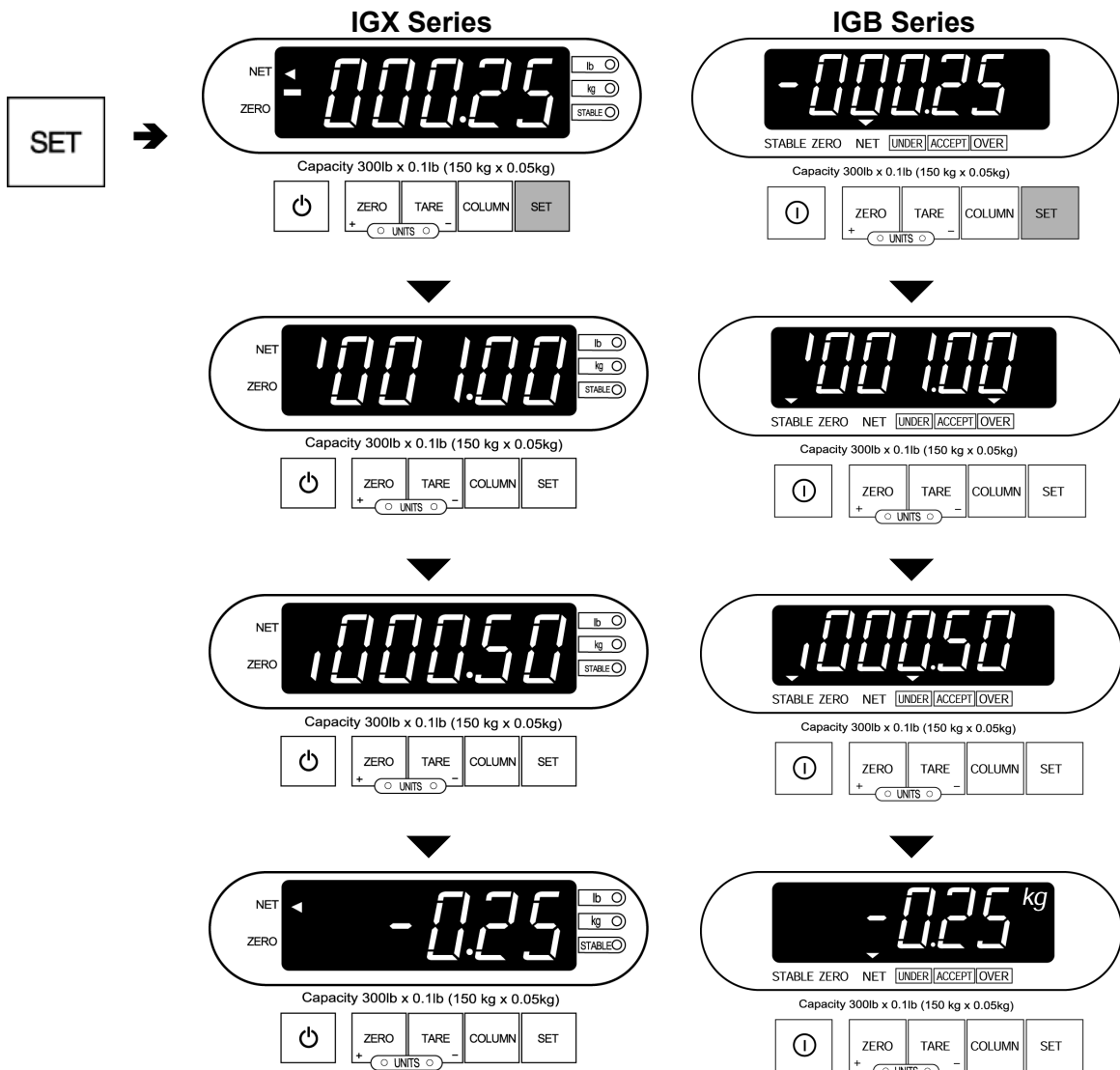

4 Place the item on the weigh platter. The display will show the net weight.

[Example] Net weight 5,970g

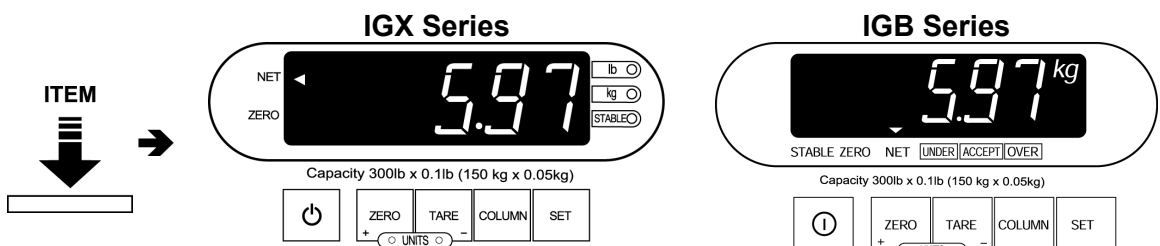

- NOTE**
- When the net weight exceeded the programmed upper weight limit, the “OVER” indicator will light up.
 - When the net weight did not reach the programmed lower weight limit, the “UNDER” indicator will light up.
 - When the net weight is between the upper and lower weight limits, the “ACCEPT” indicator will light up.

3.2 Weighing PLUs

5 After determining the PLU item weight, remove it from the weigh platter.

6 When weighing the same PLU item again, repeat steps 4 and 5 above.

NOTE *When weighing a different PLU item, repeat steps 2 through 5 above.*

7 To confirm the preset tare, press the COLUMN key.

4

**SETTING
MODE**

4.1 SETTING METHOD

1 When the power supply is turned OFF,

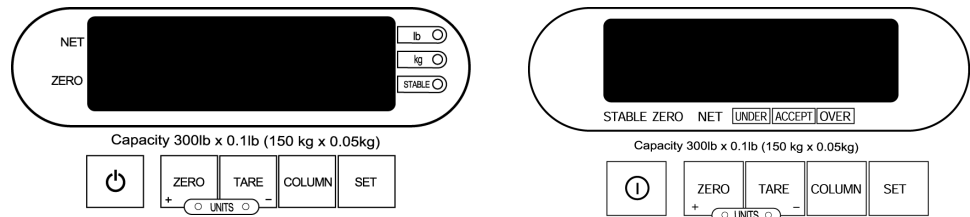

press the ON/OFF key to turn ON the power, then immediately press the COLUMN key while all display segments are lit. Then, the set value number of Setting No. 1 appears.

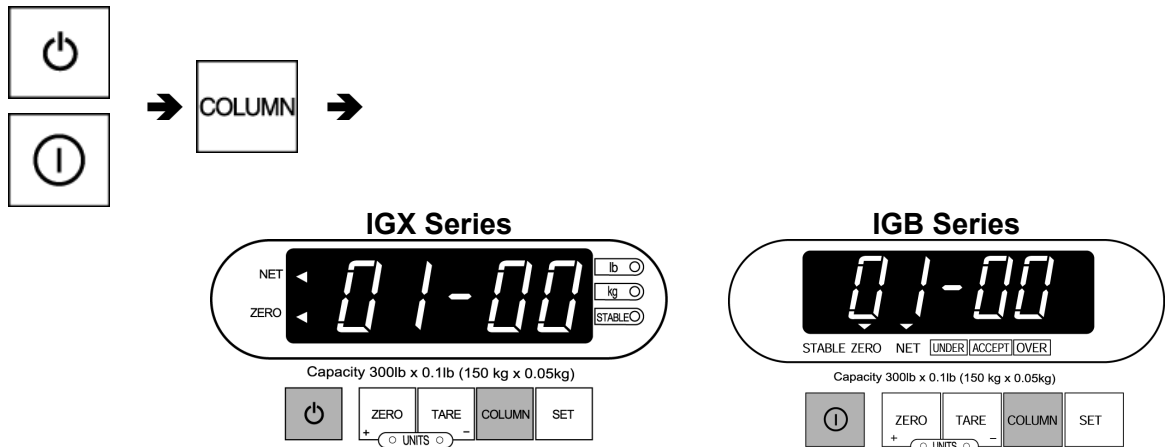

2 Change the set value by pressing the ZERO(+) key or TARE(-) key. When not changing the setting value, just press the SET key.

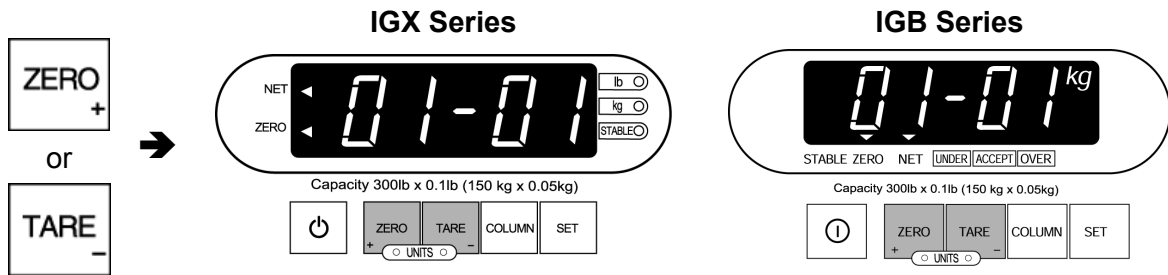

3 Select the desired Setting No. by pressing the SET key. Return to step 2 above.

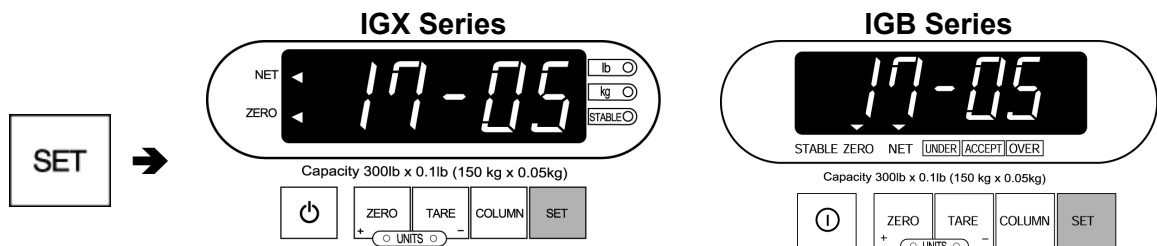

4 Press the COLUMN key to finish the setting procedure.

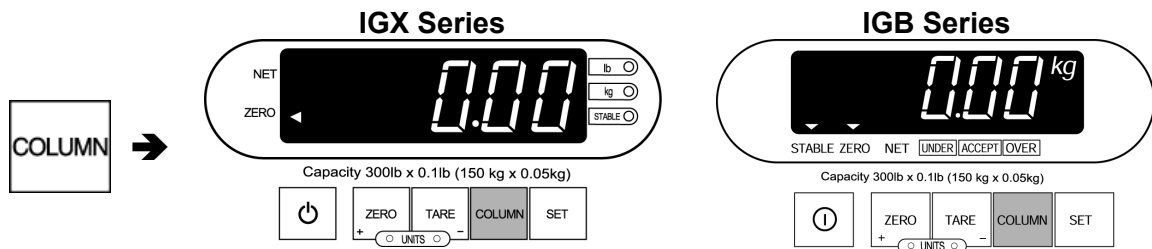

For descriptions of the setting numbers and the setting conditions of the setting value numbers, refer to the Set Value List on the following page.

4

SETTING MODE

4.2 SET VALUE LIST

■ IGX Series

Setting No.	Description of Setting	Setting Value No.	Setting Condition
F01	Key selection	00	All key valid
		01	ON/OFF key invalid (Always scale operation status when the power is turned ON)
F02	Automatic call of preset number	00	No function
		01	Preset No. 1 is automatically called when power supply is turned ON.
F03	No function		
F04	No function		
F05	No function		
F06	No function		
F07	No function		
F08	No function		
F09	No function		
F10	No function		
F11	No function		
F12	No function		
F13	No function		
F14	No function		
F15	No function		
F16	Buzzer sounding (When the buzzer is installed)	00	During stable weighing outside limit
		01	During stable weighing under "OK" condition
		02	During stable weighing under "OVER" condition
		03	No buzzer sounds even when key input is made.
		04	Buzzer sounds when key input is made and during stable weighing.
		05	Buzzer sounds only when key input is made
		06	Upper/lower limits discrimination function (during stable/unstable weighing)
F17	Automatic power-off time	00	No function
		01	10 minutes
		02	20 minutes
		03	30 minutes
		04	40 minutes
		05	50 minutes
		06	60 minutes

NOTE Shaded areas  are factory default settings.

■ IGB Series

Setting No.	Description of setting	Setting value No.	Setting condition
F01	No function		
F02	Function to automatically call preset No.	00	No function provided
		01	Preset No. 1 is automatically called when power supply is ON.
F03	No function		
F04	No function		
F05	No function		
F06	No function		
F07	No function		
F08	No function		
F09	No function		
F10	No function		
F11	No function		
F12	No function		
F13	No function		
F14	No function		
F15	No function		
F16	No function		
F17	Setting automatic power-off time	00	No function
		01	10 minutes
		02	20 minutes
		03	30 minutes
		04	40 minutes
		05	50 minutes
		06	60 minutes

NOTE Shaded areas  are factory default settings.

MEMO

5**BATTERY
CHECK****For IGB Series Only**

5.1 CHECKING BATTERY VOLTAGE

1 Press the ON/OFF key, then the self-diagnosis display appears.

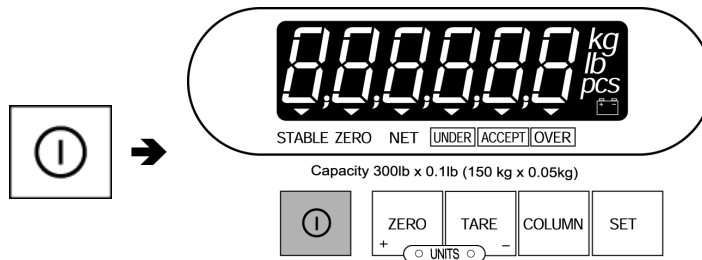

2 Immediately press the TARE key. The battery check display will appear to check the remaining battery capacity.

[Example] Voltage (for reference) 2.8 V

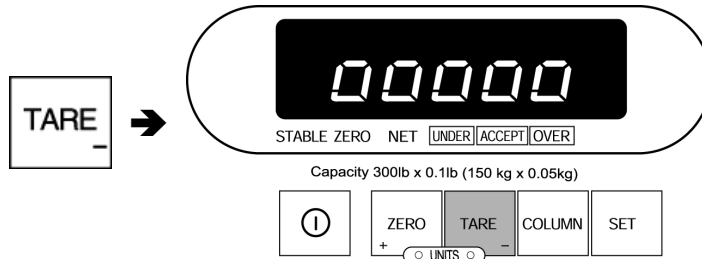

NOTE Since rechargeable batteries have a normal voltage of 1.2 V (2.4V for two batteries), their voltage cannot be indicated even when they are fully charged.

[Example] Voltage (for reference) 2.6 to 2.8 V

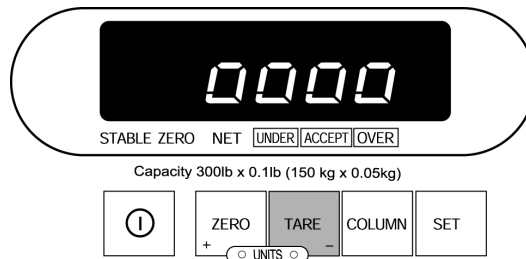

[Example] Voltage (for reference) 2.4 to 2.6 V

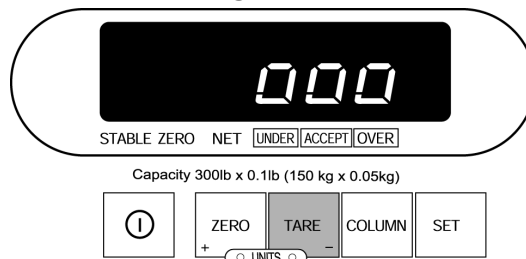

[Example] Voltage (for reference) 2.2 to 2.4 V

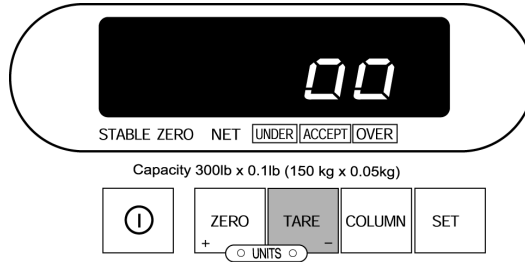

[Example] Voltage (for reference) 2.0 to 2.2 V

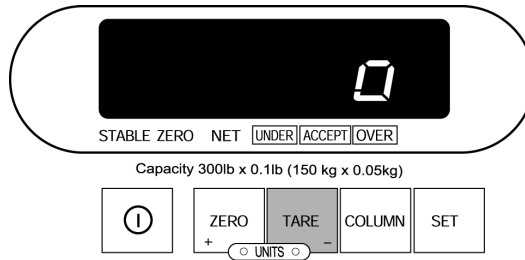

[Example] Voltage (for reference) less than 2.0 V (when batteries have to be replaced)

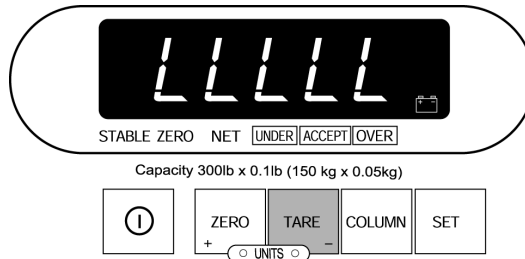

3 Press any key other than the TARE key to cancel the battery check display.

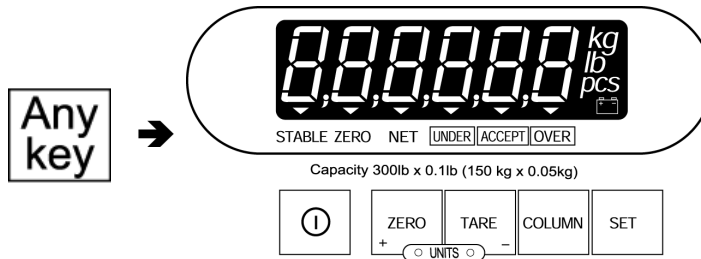

NOTE When it is necessary to replace the batteries when in use, the battery-replacement symbol will illuminate and the display indicating all numeric values will appear.

MEMO

6

APPENDIX

6

APPENDIX

6.1 TROUBLESHOOTING

If an error occurs while using the scale, take appropriate measures according to instructions in the following table.

If you have any other problems, contact your nearest ISHIDA dealer.

Symptom	Measures
The display unit does not indicate any value or symbol when the ON/OFF key is pressed.	<ul style="list-style-type: none"> • Check the power source.
“0” does not appear after finishing a display check.	<ul style="list-style-type: none"> • Place the scale on a stable flat surface. • Use the level adjuster to stabilize the scale. • Protect the scale from strong winds. • Don't place the item close to the display pole.
The weight results are different.	<ul style="list-style-type: none"> • Place the scale on a stable flat surface or table. • Check that there is nothing on the scale. • Use the level adjuster to stabilize the scale. • Protect the scale from strong winds.

6.2 SPECIFICATIONS

■ IGX Series

Item	Contents	
Model Name	IGX-60	IGX-150
<OIML Approved>		
Weighing Capacity	60 kg / 150 lb	150 kg / 300 lb
Graduation	0.02 kg / 0.05 lb	0.05 kg / 0.1 lb
Accuracy	1/3000	
Weigh Platter	550mm (L) x 400mm (W)	
Exterior Material	Display: ABS resins Display pole: Aluminum die-cast Weighing platter: Stainless (SUS304)	
Display Angle Adjust	Angle adjustable from the horizon (0°) to the front, Knob locking method	
Weight	16.8kg	
Environmental Condition	Temperature from -5°C to +40°C, Relative humidity 80%RH (max.) without condensation	
Power Source	The required transformer is provided for each 100VAC, 120VAC, 220VAC, or 240VAC.	
Power Consumption	120VAC: 46 mA	
Display	<ul style="list-style-type: none"> • VFD Numerics: 5 + 1/2 digits, Height 29 mm Mark: Zero point, Now subtracting tare, Stable • LED Over, Under, Accept 	
Tare Subtraction	<ul style="list-style-type: none"> • Key-in tare • Preset tare 	
Preset Function	[Program Mode] 10 PLUs from PLU 1 to PLU 10 (Tare weight, Upper limit, Lower limit)	
Upper Limit Range	More than the lower limit, within 5 digits (99999)	
Lower Limit Range	Less than the upper limit (5 digits in case of the upper limit = 0)	
Auto Power Off	[Setup Mode] None/10min./ 20min./ 30min./ 40min./ 50min./ 60min.	
Auto Preset Call-up	[Setup Mode] Function "Yes" / "No" selection (PLU 1 is called up when the power is ON.)	
Battery Check Mode	No	
Buzzer	Yes	
ON/OFF Switch		
Option		

6.2 Specifications

■ IGB Series

Item	Contents	
Model Name	IGB-60	IGB-150
<OIML Approved>		
Weighing Capacity	60 kg / 150 lb	150 kg / 300 lb
Graduation	0.02 kg / 0.05 lb	0.05 kg / 0.1 lb
Accuracy	1/3000	
Weighing Platter	550 mm (L) x 400 mm (W)	
Exterior Material	Display: ABS resins Display pole: Aluminum die-cast Weighing platter: Stainless (SUS304)	
Display Angle Adjust	Angle adjustable from the horizon (0°) to the front, Knob locking method	
Weight	16.0 kg (excluding batteries)	
Environmental Condition	Temperature from -5°C to +40°C, Relative humidity 80%RH (max.) without condensation	
Power Source	Two dry batteries (not attached to machine), or optional AC adapter [Battery Life] Conditions: No option, Temperature 20°, Relative humidity 60%RH Two "D" size alkaline batteries (Approx. 500H continuous use)	
Power Consumption	2.4 to 6VDC: 25mA	
Display	<ul style="list-style-type: none"> • LCD Numerics: 6 digits, Height 25 mm Mark: Battery, Zero point, Now subtracting tare, Stable, Weight unit (kg·lb), Over, Under, Accept 	
Tare Subtraction	<ul style="list-style-type: none"> • Key-in tare • Preset tare 	
Preset Function	[Program Mode] 10 PLUs from PLU 1 to PLU 10 (Tare weight, Upper limit, Lower limit)	
Upper Limit Range	More than the lower limit, within 5 digits (99999)	
Lower Limit Range	Less than the upper limit (5 digits in case of the upper limit = 0)	
Auto Power Off	[Setup Mode] None/10min./ 20min./ 30min./ 40min./ 50min./ 60min.	
Auto Preset Call-up	[Setup Mode] Function "Yes"/"No" selection (PLU 1 is called up when the power is ON.)	
Battery Check Mode	Yes	
Buzzer	No	
ON/OFF Switch		
Option	AC adapter (Dealer option)	



Design and specifications are subject to change without notice.

44 SANNO-CHO, SHOGOIN, SAKYO-KU
KYOTO, 606-8392 JAPAN
PHONE: 81-75-771-4141
FACSIMILE: 81-75-751-1634
URL: <http://www.ishidajapan.com>
